

ENGINEERING  
TOMORROW

*Danfoss*

User Guide

# Danfoss Ally™



 **zigbee**  
certified  
product

[www.ally.danfoss.com](http://www.ally.danfoss.com)

<b>1. Danfoss Ally™ Introduction</b>	<b>3</b>
1.1 Key Features	3
1.2 Identify your Danfoss Ally™	3
1.3 Danfoss Ally™ Components and Communication Map	4
<b>2. Content in the Package of the Danfoss Ally™ Gateway</b>	<b>5</b>
<b>3. Technical Specifications</b>	<b>5</b>
<b>4. Download and install the Danfoss Ally™ App. The first use.</b>	<b>6</b>
<b>5. Main Screen and Menu Overview</b>	<b>8</b>
5.1 Rooms with several Radiator Thermostats	9
5.2 Add new Devices to an existing System	9
<b>6. Content in the Package of the Danfoss Ally™ Radiator Thermostat</b>	<b>10</b>
6.1 Content in the Package	10
6.2 Overview of Valve Adapters	10
6.3 Installing the right Adapter	11
6.4 Inserting the Batteries	12
6.5 Mounting the Danfoss Ally™ Radiator Thermostat	12
6.6 Download the Danfoss Ally™ App	13
6.7 Danfoss Ally™ Intelligence and automatic Adjustments	13
6.8 Removing the Danfoss Ally™ Radiator Thermostat	14
6.9 Resetting the Danfoss Ally™ Radiator Thermostat to default Settings	14
<b>7. Technical Specifications</b>	<b>15</b>
<b>8. Display</b>	<b>17</b>
8.1 Display Screen	17
8.2 Display Symbols	17
8.3 Display Rotation	17
8.4 Stand-alone mode	17
<b>9. Functions and Settings Overview</b>	<b>18</b>
9.1 Setting Temperatures	18
9.2 Create your own Schedule	19
9.3 Vacation Mode	19
9.4 Edit a Vacation	20
9.5 Cancel an existing Vacation Programme	20
9.6 Pause Mode	20
<b>10. Danfoss Ally™ Room Sensor</b>	<b>24</b>
10.1 Facts about the Danfoss Ally™ Room Sensor	24
10.2 Technical Specifications	25
10.3 Installation	25
<b>11. Danfoss Ally™ Boiler Relay</b>	<b>27</b>
11.1 Facts about the Danfoss Ally™ Boiler Relay	27
11.2 Technical Specifications	27
<b>12. Danfoss Ally™ Protect RA</b>	<b>28</b>
12.1 Installation	28
12.2 Technical Specifications	29
<b>13. Danfoss Ally™ Power Module 24V</b>	<b>29</b>
13.1 Installation	30
13.2 Technical Specifications	30
<b>14. Danfoss Icon™/Icon 2™ – Room Thermostats for Floor Heating</b>	<b>31</b>
14.1 Facts about Danfoss Icon™/Icon 2™	31
14.2 Danfoss Icon™ Specifications	32
14.3 How to install Danfoss Icon™	33
14.4 Connecting Danfoss Icon™ to Danfoss Ally™	34
14.5. Frequently asked questions on Danfoss Icon™ section	36
14.6 Danfoss Icon 2™ Specifications	37
14.7 Connecting Danfoss Icon 2™ to Danfoss Ally™	39
<b>15. Data Security</b>	<b>41</b>
<b>16. Safety Precautions</b>	<b>41</b>
<b>17. Disposal</b>	<b>41</b>

## 1. Danfoss Ally™ Introduction

The Danfoss Ally™ gives you all the benefits of a full-blown smart heating system – in a simple easy-to-use app. With Danfoss Ally™ you get full control of your radiator and floor heating as well as your heating bill. From virtually anywhere and at any time whether you're at home or on the go. You can even control your heating system with your voice as Danfoss Ally™ speaks with many of your other IoT friends.



The intuitive app user interface is designed to make your everyday life as simple and comfortable as possible. The app guides you through the quick set-up. Lets you fit your home heating to your daily routines. And gives you the complete overview and control at all times.

The Danfoss Ally™ smart heating solution is Zigbee 3.0 certified. This means that it speaks the same wireless language as tons of other smart home devices around the globe. Allowing you to connect Danfoss Ally™ to your existing smart home setup. And to make your smart home even smarter.

### 1.1 Key Features

- Full control of the radiator and underfloor heating via the app on your smartphone
- A higher level of comfort and energy efficiency by adapting room temperature to a daily schedule
- Easy to use and install with the intuitive app control
- Designed to bridge form and functionality
- Remote control from everywhere
- Up to 30% energy savings
- Fits 95% of all valves
- A maintenance-free thermostat – the battery lasts up to two years
- Works with Amazon Alexa, Google Assistant
- Excellent temperature control
- EPBD compliant
- Open API
- Zigbee 3.0 certified

### 1.2 Identify your Danfoss Ally™

Product	Installation Guide - Languages	Code no.
Danfoss Ally™ Gateway	EN, DE, DA, FR, IT, PL, CS, UA, RU, ET, LV, HR, IS, SK, SL, TR	014G2400
Danfoss Ally™ Starter Pack	EN, DE, DA, FR, IT, PL, CS, UA, RU, ET, LV, HR, IS, SK, SL, TR	014G2440

### 1.3 Danfoss Ally™ Components and Communication Map



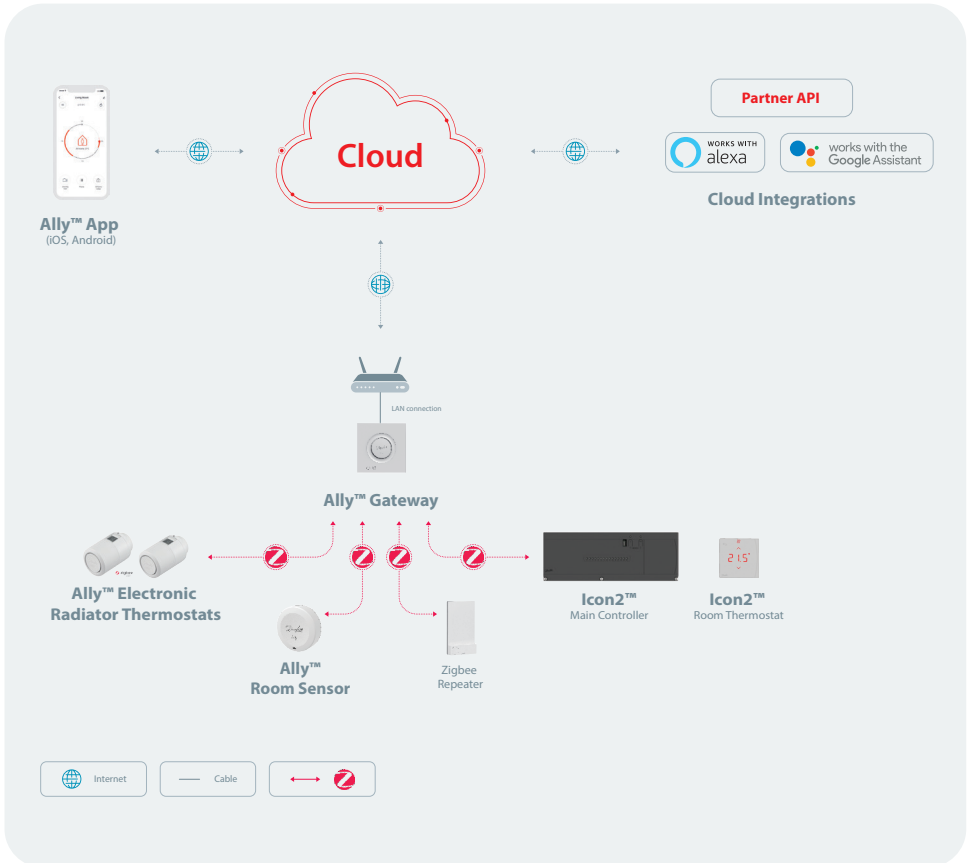

We know how interconnectivity is the secret behind a truly smart home. Where devices are flawlessly connected in an intelligent network. In a smart ecosystem that allows you to control your world in your way.

The Danfoss Ally™ is Zigbee 3.0 certified. This means that it speaks the same wireless language as tons of other smart home devices around the globe. Allowing you to connect Danfoss Ally™ to your existing smart home setup. And make your smart home even smarter.

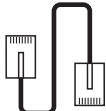

## 2. Content in the Package of the Danfoss Ally™ Gateway

The Danfoss Ally™ Gateway is supplied with the quick guide, LAN cable, power supply cable.

			
<p>Danfoss Ally™ Gateway</p>	<p>Quick Guide</p>	<p>LAN cable</p>	<p>Power supply</p>

## 3. Technical Specifications

<b>Danfoss Ally™ Gateway</b>	
<b>Device Function</b>	Smart Home Gateway
<b>Recommended Use</b>	Residential indoor (pollution degree 2)
<b>Application</b>	Radiators, water-based floor heating
<b>LED Indicators (green)</b>	Power/Status, Network Connection
<b>Button</b>	Press Reset Button for 5 sec. to perform factory reset
<b>Power Supply</b>	5 VDC
<b>Adaptor</b>	110 V ~ 240 VAC, 5V 1A DC
<b>Power Consumption / Standby</b>	< 5 W / < 2 W
<b>Wired Communication</b>	10/100M Ethernet Port (RJ45, LAN)
<b>Wireless Communication</b>	Zigbee / IEEE 802.15.4
<b>Transmission Frequency / Power</b>	2.4 GHz / < 20 dBm (79 mW)
<b>Transmission range inside buildings</b>	up to 30 m
<b>Firmware Update</b>	Support for over the air updates
<b>Operation Temperature</b>	-10 °C to 55 °C
<b>Storage Temperature</b>	-20 °C to 60 °C
<b>Color</b>	RAL 9016
<b>Size</b>	95 mm x 95 mm x 23 mm
<b>IP class</b>	20
<b>Integrations</b>	Amazon Alexa, Google Assistant, Partner API
<b>Approval, markings etc.</b>	

## 4. Download and install the Danfoss Ally™ App. The first use

The Danfoss Ally™ gives you all the benefits of a full-blown smart heating system – packed in a simple easy-to-use app. No more control unit – now your smartphone is all you need to control and monitor all your radiators and floor heating.

In this way, you're always in control of your home heating. Whether you're at home or on the road. You simply get more flexibility and comfort without the need for complicated hardware.

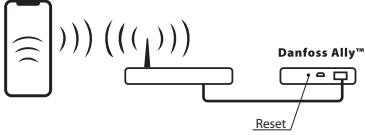
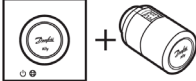
<p><b>Step 1.</b> Download the Danfoss Ally™ App from Google play or App Store</p>	
<p><b>Step 2.</b> To enable smartphone control, your Danfoss Ally™ Gateway needs to be connected to the mains power and the Ethernet. Use the cables provided with the Ally™ Gateway.</p>	
<p><b>Step 3.</b> Connect your Danfoss Ally™ Gateway to the network. <i>Make sure your mobile device is connected to Wi-Fi from the same router as the gateway is connected to with cable.</i> <i>In case of unsuccessful connection, press and hold "Reset" button for 5 seconds until the LEDs start blinking, then release the button and repeat connection.</i></p>	
<p><b>Step 4.</b> Finalise system setup by adding the subdevices.</p>	

The total number of units for the one Danfoss Ally™ Gateway must not exceed 199 mains and battery-powered devices:

Danfoss Ally™ Radiator Thermostat	32 units
Danfoss Ally™ Room Sensor	
Danfoss Ally™ Zigbee Repeater	199 units
Danfoss Ally™ Boiler Relay	
Danfoss Icon™ Zigbee Module / Danfoss Icon™ Master Controller (floor heating)	
Danfoss Icon2™ Main Controller (floor heating)	
Danfoss Icon™ Room Thermostat	
Danfoss Icon2™ Room Thermostat	
Number of devices per room	50 units
Number of rooms per Home/Family	20 pcs.
Number of Homes/Families per one account	20 pcs.
Number of devices per account (20 homes/families and 200 units per each)	4000 units
Number of Home/Family members per one account	20 pcs.
Number of devices per one Home/Family	200 units

① Install the Danfoss Ally™ App on your smartphone

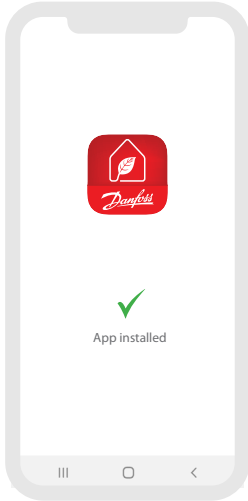

② Open the app and register your account

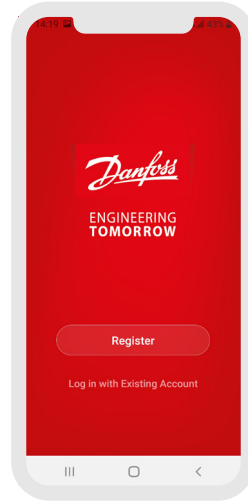

③ Add Your Danfoss Ally™ Gateway

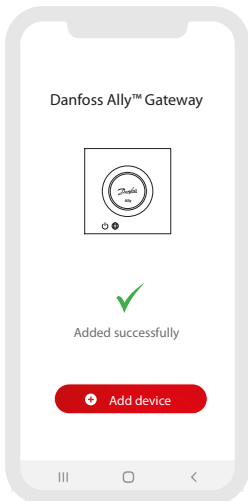

④ Add your Danfoss Ally™ battery and mains powered subdevices

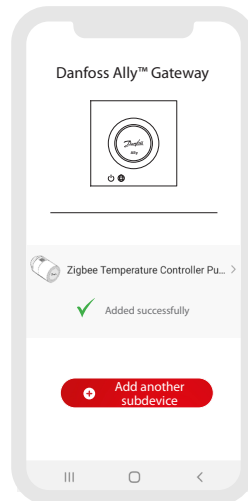

! Screens may be different from the actual ones in the Danfoss Ally™ App

## 5. Main Screen and Menu Overview

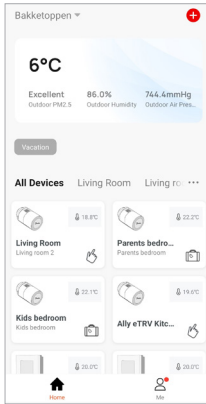

'At home' screen provides general information about weather and device status in the tiles.

Under each room name, all assigned devices to the particular room are shown, as well as heating status and current room temperature.

'Vacation' button on the top left-hand corner allows to choose specific rooms and set up away temperature during vacation period.

*NOTE: If the set temperature of a room is lower than the vacation temperature, Danfoss Ally™ will not put this room on a 'Vacation' and such rooms will not appear in the room selection list.*

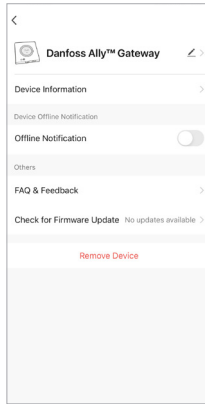
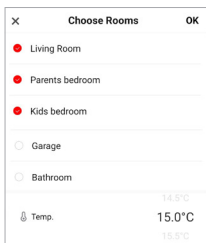

Press Ally™ Gateway tile on the Home screen and tap on the pen upper right corner to get to the Ally™ Gateway menu.

The menu contains:

- 'Device information' about Virtual ID, IP and MAC address, Time Zone.
- 'Share Device' for home members, 'FAQ & Feedback' to find answers or submit request.
- 'Check for Firmware Update' for Main Module and Zigbee Module and 'Remove Device' with all related devices which have previously been connected.

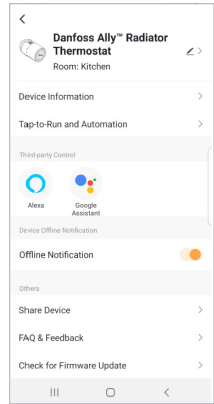

Pressing 'Radiator Thermostat' tile on the Home screen and tap on the pen upper right corner to get to 'Radiator Thermostat' menu.

The menu contains:

- 'Device information' about Virtual ID, Time Zone.
- 'Third-party Control' to connect system with Amazon Alexa and Google Assistant voice control.
- 'FAQ & Feedback' to find answers or submit request.
- 'Check for Firmware Update' for Zigbee Module and 'Remove Device' from current room.



### 5.1 Rooms with several Radiator Thermostats

<p>The screenshot shows the 'MyHome' app interface. At the top, it displays a temperature of 10°C and various environmental metrics. Below, there's a 'Vacation' button and a section for 'All Devices'. Under 'Master Bedroom', there are several tiles for 'Danfoss Ally™ Radiator Thermostat' and one for 'Danfoss Ally™ Gateway'.</p>	<p>If several radiator thermostats are assigned to one room, then the Danfoss Ally™ App will automatically create a group tile. This is to ensure settings are synchronized between devices in the same room. It is recommended to always adjust a schedule and preferred temperatures for the entire group, and not for single devices, to ensure the most efficient performance.</p> <p>If settings are changed on an individual device, then data is not synchronised with the group.</p>
---	--

### 5.2 Add new Devices to an existing System

<p>This screenshot is identical to the one in section 5.1, showing the app's home screen with the 'Danfoss Ally™ Gateway' tile visible among other devices.</p>	<p>The screenshot shows the 'Add subdevice' screen. At the top is an image of the Danfoss Ally™ Gateway. Below it, the text 'Danfoss Ally™ Gateway' is displayed. Under 'Online devices: 2', there are two 'Danfoss Ally™ Radiator Thermostat' entries. At the bottom, there is a red '+ Add subdevice' button.</p>	<p>The screenshot shows a list of device types to be added: Danfoss Ally™ Radiator Thermostat, Danfoss Icon™, Danfoss Icon2™, Danfoss Ally™ Room Sensor, Danfoss Ally™ Air, and Danfoss Zigbee Repeater. Each item has a right-pointing arrow.</p>
<p>Click on the 'Danfoss Ally™ Gateway' tile and add the needed subdevice from the suggested list.</p>	<p>Click on the 'Add subdevice' button.</p>	<p>Choose the needed device from the list and continue process following the installation flow guideline.</p>

## 6. Content in the Package of the Danfoss Ally™ Radiator Thermostat

### 6.1 Content in the Package

Danfoss Ally™ Radiator Thermostat is supplied with the adapters as listed in 6.2. In addition each pack contains:

<p>Danfoss Ally™</p>	<p>Quick Guide</p>	<p>Requires 2x AA batteries</p>	<p>Allen Key</p>
<p>Adapters B2C</p>		<p>Adapters B2B</p>	

### 6.2 Overview of Valve Adapters

The standard adapters provided with the Danfoss Ally™ Radiator Thermostat, cover 95% of all valves. Additional adapters are available as accessories.

Adapter type	Code no.	Adapter	Valve
For Danfoss RA valves	014G0251		
For M30 x 1.5 (K) valves	014G0252		
For Danfoss RAV valves	014G0250		
For Danfoss RAVL valves			

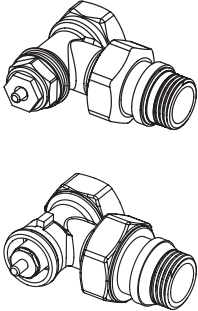
Adapter type	Code no.	Adapter	Valve
<p>For Caleffi and Giacomini valves</p> <p>(Both adapters are supplied for the Italian product version)</p>	<p>014G0263</p>		

### 6.3 Installing the right Adapter

The Danfoss Ally™ packaging contains a quick guide to help you find the correct adapter for your valve type. If you need an additional help in finding the correct adapter, please follow the QR code on the quick guide and find “How-to” video instructions.

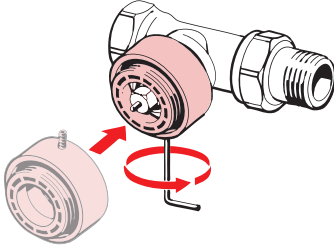
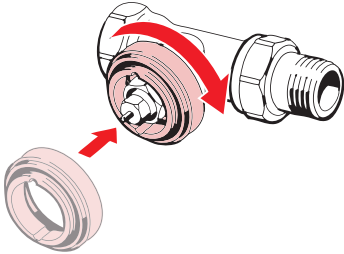
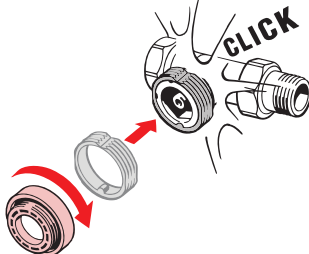
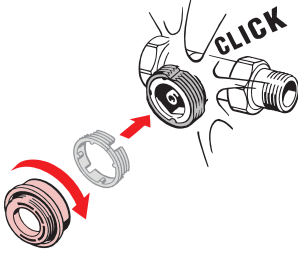
<p><b>Adapter for RA valves</b></p> 	<p><b>Adapter for M30 x 1.5 (K) valves</b></p> 
<p><b>Adapter for RAV valves</b></p> 	<p><b>Adapter for RAVL valves</b></p> 

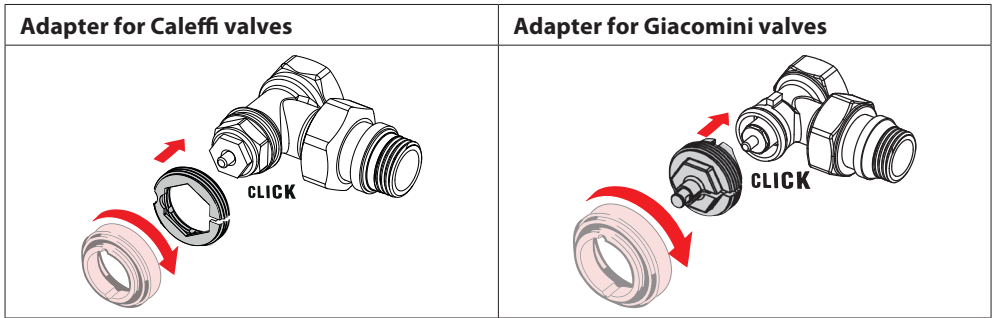

### 6.4 Inserting the Batteries

Remove the battery cover as shown in the diagram and insert two AA batteries. Make sure the batteries are correctly oriented.

Rechargeable batteries **must not** be used. When replacing batteries, the time and date settings are lost immediately. After replacing batteries, re-connect to a smartphone to activate a schedule. The red ring will flash. Re-connect to the App and the time and date will be restored. If you do not re-connect, the sensor will remain in manual mode.

The low battery symbol  is displayed on the Radiator Thermostat and in the Ally™ app approx. one month before the batteries are empty. If the batteries are completely empty, the Danfoss Ally™ Radiator Thermostat will leave the valve in frost protection position, which means that the heat flow will run through the radiator and protect the heating system from damage.

Estimated battery life time is up to 2 years.

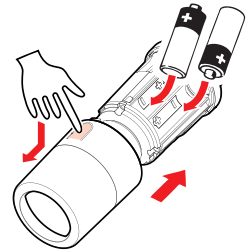

### 6.5 Mounting the Danfoss Ally™ Radiator Thermostat

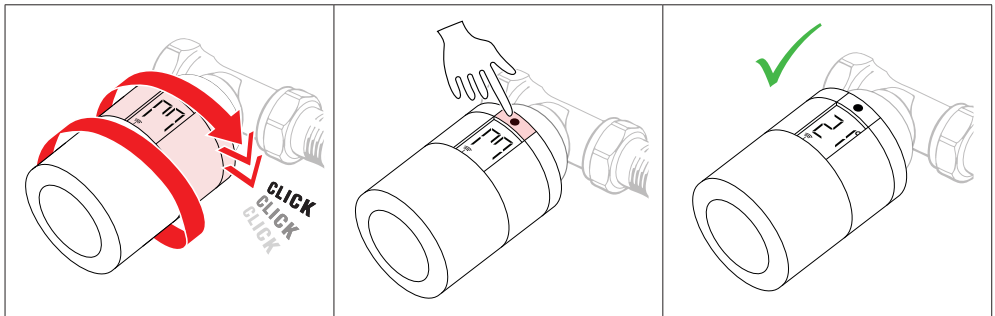

Screw the Danfoss Ally™ Radiator Thermostat onto the mounted adapter until a click sound is heard. Once the thermostat is tightened properly, then adjust the display to your preferred display orientation.

A large  is flashing in the display to indicate that installation mode is activated.

Press and hold the button  for 3 seconds.

The temperature set point will show on the screen once the Danfoss Ally™ Radiator Thermostat is mounted.

*NOTE that you can find how-to videos on the [Danfoss Ally™ support page](#) and on YouTube.*

## 6.6 Download the Danfoss Ally™ App

Download the Danfoss Ally™ App.



Youtube  
Video Guide

## 6.7 Danfoss Ally™ Intelligence and automatic Adjustments

During the first week after installation, the Danfoss Ally™ Radiator Thermostat will automatically begin to learn about and adjust itself to your heating system. During this process you might experience that the thermostat reacts slowly or turns the heat up or down by itself. The intelligence in the Danfoss Ally™ Radiator Thermostat requires this period of time to learn about the heating system, and it is a normal and necessary part of the adjustment process.

### 1. Adjusting to the valve

During the first night of operation, the Danfoss Ally™ Radiator Thermostat will shut off the radiator heat and then open again to detect the exact opening point of the valve. This will allow the Danfoss Ally™ Radiator Thermostat to control the heat as efficiently as possible. If necessary, the procedure is repeated once a night for up to a week.

### 2. Pre-heat

If you activate adaptive learning in your Danfoss Ally™ App, the Danfoss Ally™ Radiator Thermostat spends the first week of operation detecting and learning when it is necessary to start heating the room, in order to reach the correct temperature, at the correct time. This intelligence will continuously adjust the heating time compared to seasonal temperature changes.

### 6.8 Removing the Danfoss Ally™ Radiator Thermostat

1.

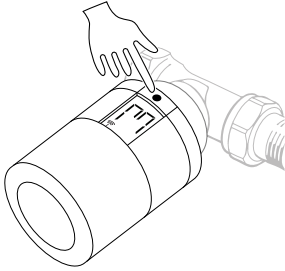

Press and hold ● until large flashes. This indicates you are in mounting mode

2.

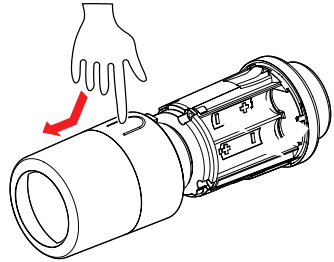

Remove the cover.

3.

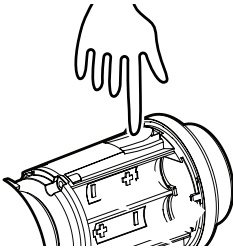

Press firmly on the tab and unscrew the thermostat from the adapter.

Video tutorial:  
[Danfoss Ally™ Support Page](#)

### 6.9 Resetting the Danfoss Ally™ Radiator Thermostat to default Settings

1.

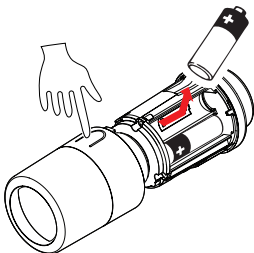



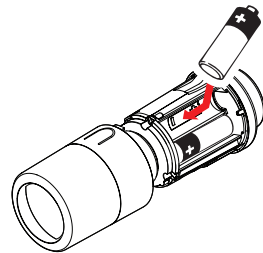

Remove the cover and take out one battery.

2.



Press and hold ●, keep holding while reinserting the battery. The screen will go blank after approx 3 seconds. The thermostat is now re-set.

## 7. Technical Specifications

Thermostat type	Programmable electronic radiator valve controller
Recommended use	Residential (pollution degree 2)
Actuator	Electromechanical
Display	LCD with white backlight
Software classification	A
Control	PID
Power supply	2 x 1.5 V alkaline AA batteries
Power consumption	3 mW in standby, 1.2 W when active
Trasmission Frequency / Power	2,4 GHz / < 40 mW
Battery life	Up to 2 years
Low battery signal	Battery icon will flash in display.
Ambient temperature range	0 to 40 °C
Transportation temperature range	-20 to 65 °C
Maximum water temperature	90 °C
Temperature setting range	5 to 35 °C
Clock accuracy	+/- 10 min/year
Spindle movement	Linear, up to 4.5 mm, max. 2 mm on valve (1 mm/s)
Noise level	<30 dBA
Safety classification	Type 1
Color	RAL 9016
Open-window function	Activated at temperature decrease or by Zigbee command
Weight (incl. batteries)	198 g (with RA adapter)
IP class	20 (not to be used in hazardous installations or in places where it will be exposed to water)
Integrations*	Partner API, Google Assistant, Amazon Alexa
Approvals, markings etc.	    

\* Requires the Danfoss Ally™ Gateway

[The Danfoss Ally™ App software versions](#)

**Danfoss eTRV E-error codes description**

<b>Alarm code</b>	<b>Problem</b>	<b>Solution</b>
<b>E1</b>	Top PCB sensor error.	The temperature sensor is damaged, return to a dealer.
<b>E2</b>	Side PCB sensor error.	The temperature sensor is damaged, return to a dealer.
<b>E6</b>	Motor error.	Motor jammed, try to remove/insert battery, if the error persists try to reset, if still no positive result return to a dealer. <i>NOTE! The eTRV will retry after 20 min. The error code will remain on the display, until cleared by the controller.</i>
<b>E8</b>	Invalid communication (Zigbee).	Try to remove/re-insert battery. If the error persists, try to reset. If still no positive result, return to a dealer.
<b>E9</b>	Valve closing ability.	It appears the valve cannot be closed correctly. Please check the installation and/or contact an installer.



## 8. Display

### 8.1 Display Screen

Short press on ● and the display screen appears.

The Danfoss Ally™ Radiator Thermostat is displaying the **set temperature**, not the **measured room temperature**.

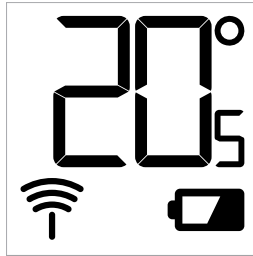

### 8.2 Display Symbols:



Installation Mode must always be activated when installing or removing the Danfoss Ally™ Radiator Thermostat. The thermostat may be irreparably damaged if not in the correct position during installation.



Temperature is shown in degrees Celsius. The Danfoss Ally™ Radiator Thermostat is displaying the **set temperature**, not the **measured room temperature**.



The antenna symbol flashes when you need to connect the app to the thermostat.



Low battery. The battery icon will flash on the display.

### 8.3 Display Rotation

The Danfoss Ally™ Radiator Thermostat can be mounted in a horizontal or vertical position, depending on your radiator valve. You can set the display rotation to either 'horizontal' or 'vertical' within the Danfoss Ally™ Radiator Thermostat App under advanced settings.

### 8.4 Stand-alone Mode

Danfoss Ally™ Radiator Thermostat can also be used as a stand-alone thermostat without connection to the app.

#### Functionality is reduced.

Use the handwheel to adjust the temperature. The display shows the required temperature and not the room temperature. In manual mode, there are no comfort or setback temperatures or times set.

## 9. Functions and Settings Overview

		Temporary setpoint
		Room temperature
		Manual mode
		Heating schedule
		Away mode
		Pause
		At home mode
		<p>'Pre-Heat' is used to ensure you have the right temperature when you want it. When 'Pre-Heat' symbol is shown, it means that it is ramping up to the next scheduled 'At Home' mode.</p>

### 9.1 Setting Temperatures

Set your own temperatures for your setback periods in the Danfoss Ally™ App.

	<p>For changing temperature press Menu button  on the main screen → Settings → Set temperature.</p> <p>Scroll on temperatures to set your preferred permanent room temperature.</p> <p>In case you need to set a temporary temperature, just turn the thermostat wheel and choose desired value. The temporary temperature changes are valid until the next scheduled temperature change.</p> <p>The Danfoss Ally™ Radiator Thermostat can be set from 5 °C to 35 °C.</p> <p>Danfoss recommend a difference between 'At Home' temperature and 'Away/Asleep' that does not exceed 4 degrees.</p>
--	---

## 9.2 Create your own Schedule

<p>To make temperature adjustments go to the Menu → settings → Temperatures. Within the Danfoss Ally™ App you can create your own schedule. You can choose any setback times within 24 hours and set up to 3 At Home periods per day.</p>	<p>The weekly schedule shows the 'At Home' periods in red. The 'copy' functionality allows to copy the schedule to other days.</p>	<p>The Danfoss Ally™ App display shows both the 24 hour clock wheel, showing 'At Home' time in red and a summary of schedule, with the detailed times set. The minimum 'At Home' period is 30 minutes.</p>

## 9.3 Vacation Mode

Use 'vacation' programme to save energy, when you are away or at home. Vacation programme is set within the Danfoss Ally™ App.

<p>'Vacation' mode 'Away' or 'At Home' can be planned or set straight away (Now). <i>Please note that in order to choose the 'At home' mode, you must have 'Saturday' scheduled beforehand. This is because Ally™ will use the Saturday schedule settings for the 'Vacation'.</i></p>	<p>The Danfoss Ally™ App display confirms your 'Vacation At Home' with options 'Now' or by 'Plan'.</p>	<p>The Danfoss Ally™ App display confirms your rooms. You can select the rooms which you want to set to 'Vacation Mode'.</p>	<p>Planned vacation uses a calendar and time setting.</p>	<p>Schedule 'Vacation' in the Danfoss Ally™ App.</p>

### 9.4 Edit a Vacation

If returning earlier than expected you might wish to shift from the 'Vacation' programme to your normal schedule.

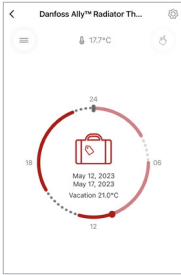

When in 'Vacation' setting the Danfoss Ally™ App will give options to end the vacation period or edit the dates and times.

### 9.5 Cancel an existing Vacation Programme

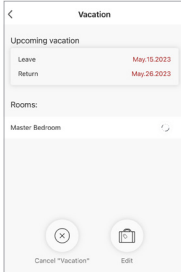

If the vacation is planned for the future you can simply edit the dates or cancel the programme.

### 9.6 Pause Mode

The Pause programme keeps the setback temperature until another programme is selected.

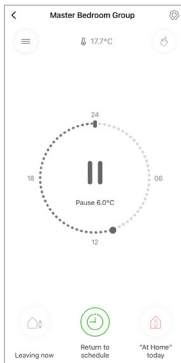

When the Danfoss Ally™ system is turned down to a Min level manually, a notification banner is shown, and center icon switches to 'Pause'.

To exit the 'Pause' click the clock icon to return to the scheduled or manual setpoint.

**Frequently asked questions on Danfoss Ally™ section:****• What is the difference between Danfoss Eco™ and Danfoss Ally™?**

**Danfoss Eco™** is a stand-alone thermostat, where all control and programming takes place on one thermostat at a time, either by using the thermostat's turning function or via Bluetooth and the Danfoss Eco App. It has a maximum range of 10 m.

**Danfoss Ally™** is a smart home system for both radiator systems and combined radiator and floor heating systems. Danfoss Ally™ can be voice-controlled via Google Home and Amazon Alexa and with the open API, developers can create a real smart home system. Danfoss Ally™ is controlled by a gateway that connects to the home's router and is operated exclusively via the Danfoss Ally™ App.

**• Is there a child lock feature?**

Yes, in the Danfoss Ally™ App, you can enable child protection on the thermostat. This means that the turning function on the thermostat is deactivated and the control is done exclusively via the app. You will find the child lock slide button in the settings menu, on each individual thermostat in the app.

**• Why some of devices seems to be offline?**

The gateway should be placed in a central place in the house, from where there is free access to all devices. If this is not possible, one or more repeaters can be added.

**• What does 'Pre-Heat' mean? Why does my radiator heat up before the set time?**

The 'Pre-Heat' function ensures that the comfort temperature is reached at the desired time. The heating time is continuously adjusted according to seasonal temperature changes.

**'Pre-Heat' ensures that the desired temperature is reached at the set time**

This means that the thermostat will start heating before the set time to ensure that the room is at the desired temperature when you want it. If the thermostat only starts heating at the set time, the room will not have the right temperature.

When the heating starts depends on how much the temperature has been lowered (we recommend a maximum difference of 4°C.), the size of the radiator and the room, the season, drafts and the home insulation.

**'Pre-Heat' uses data from the previous seven days, so that the desired temperature is reached at the right time.**

This means that over the course of a week, the system gets to know your heating system and it is then able to start heating in time to achieve the desired temperature at the set time.

During the first week and during seasonal changes, you may experience that the heat can fluctuate slightly up and down. This is completely normal and after that, you will be able to enjoy sleeping in a cool home and at the same time wake up to a nice and warm house.

- **Can I put my entire heating system on vacation?**

Yes, you can put all or selected rooms on 'Vacation' mode via the Danfoss Ally™ App.

Here's how you do it:

1. Press the 'Vacation' button and then select 'Vacation' mode: **'Vacation Away'**: Used if the family is away and the temperature of the rooms needs to be lowered. **'Vacation At Home'**: Used if you are at home, e.g. during the Christmas holidays. The normal schedule is over-written so that the heat is on all day. This feature automatically selects the Saturday option from your schedule.
2. Choose when the heating system should go into 'Vacation' mode: **Now**: 'Vacation' mode will be in effect from now until you choose to stop it again. It is only when you manually stop the 'Vacation' mode that the heating system starts up again – or that the normal schedule takes over. **Schedule**: Select a from and to date when the vacation mode should apply. When this function is used, the normal schedule will take over when the holiday period is over. This means that the house will be heated when the family returns home from a skiing holiday.
3. Choose which rooms to put in vacation mode.
4. Choose which temperature the rooms in question should be set to.

'Vacation' mode is now active and can be seen by the fact that the 'Vacation' button is gray in the Danfoss Ally™ App.

- **Does the Ally™ Radiator Thermostat have a protection against limescale?**

If the radiator is left off for a long time, scale and limescale can build up on the inside of the pipes and radiator. This causes the radiator to become less efficient over time. Ally™ Radiator Thermostat has a built-in function to prevent this. It automatically opens the tap for 30 seconds every Thursday.

- **Can I also control my floor heating?**

Danfoss Ally™ Gateway can be connected to a Danfoss Icon™ Master controller (model version "OTA") using the Danfoss Icon™ Zigbee module, which allows control of water-based floor heating. The Icon2™ Main Controller can be added to the Ally™ Gateway directly without Icon™ Zigbee module.

**Please, note** that Danfoss Ally™, on the other hand, is NOT suitable for installation on under-floor heating that is controlled by a FJVR return valve.

- **What happens when my Ally™ Radiator Thermostat is low on battery?**

The batteries last up to 2 years. One month before the total battery discharge, a low battery symbol is shown on the thermostat display and PUSH notifications inform about the necessity of replacing the batteries.

A good tip is to set a calendar reminder for 2 years in the future, where you change all the batteries at once – even if they have not necessarily run out yet.

If you do not change the batteries before they run completely dry, the thermostat will open and thus ensure that heat constantly flows through the radiator. This is a safety mode to ensure that frost damage does not occur, if the thermostat is placed in an otherwise cold room.

- **How does the Ally™ optimize the heating in my house ?**

Danfoss Ally™ system is a smart heating solution that provides accurate heating control and secures the best indoor environment.

Room temperature control is based on an intelligent algorithm and designed to optimize all indoor factors which potentially could have a negative influence on the efficiency of heating regulation.

Such factors as insufficient radiator size and quantity, thermostat location and installation type, heat source temperature, room insulation, indoor air convection, etc.

All these factors could bring some room temperature regulation “tolerance” which we shouldn’t compare with a heat meter tolerance as an example. But the Ally™ regulation efficiency can be automatically adjusted either by the system itself or by a professional installer to the optimal for any specific conditions.

## 10. Danfoss Ally™ Room Sensor

The Danfoss Ally™ Room Sensor is designed especially for covered radiators when the radiator thermostat is hidden behind a curtain or a piece of furniture. But even adding the Room Sensor to a regular set-up it becomes even easier to achieve a perfect indoor climate.

The small and discrete room sensor measures both temperature and humidity, and communicates back to the Ally™ Gateway.

What you get: temperature perfection in every room.



### 10.1 Facts about the Danfoss Ally™ Room Sensor:

- Measures the temperature and humidity
- Increases indoor comfort
- Neutral, compact design which fits with most interiors
- Easy installation with no tools needed
- Controlled from the Danfoss Ally™ App
- Battery-powered with a battery lifetime of up to 5 years
- Zigbee 3.0 certified



The Danfoss Ally™ Room Sensor is an indoor electronic sensor for measuring room temperature and humidity.

The room sensor is a part of Danfoss Ally™ system, which is used for wireless linking and controlling of heating systems in a residential and light commercial buildings.

The Danfoss Ally™ Room Sensor has a built-in temperature and humidity sensor, which measures ambient temperature and humidity. It allows you to increase the indoor comfort and control the heating in the room where installed.

The Danfoss Ally™ Room Sensor is a Zigbee certified product, compatible with the Danfoss Ally™ Gateway and with the third party certified systems using a Zigbee technology. It is a battery powered device, compact, easy to install and an ideal for the covered radiators as an external temperature measurement solution.

*NOTE: If you have a Danfoss Ally™ Room Sensor in your room setup, the front sensor of the Radiator Thermostat, which is responsible for measuring the temperature in the room, will be deactivated.*

Product	Installation Guide – Languages	Code no.
Danfoss Ally™ Room Sensor	EN, DE, DK, FR, IT, PL, CZ, UA, SE, RU, ES	014G2480



## 10.2 Technical Specifications

Danfoss Ally™ Room Sensor	
Thermostat type	Room Sensor
Recommended use	Residential and light commercial buildings
Display	LED indicator
Power supply	CR2450 battery
Transmission Frequency/Power	2,4 GHz/ <10 dBm EIRP (PSD)
Battery life	Up to 5 years
Temperature detection range	-20°C to 60°C
Weight (incl. battery)	25 g
IP class	20
Integrations*	Partner API, Google Assistant, Amazon Alexa
Approvals, markings etc.	

\* Requires the Danfoss Ally™ Gateway.

## 10.3 Installation

<p><b>Step 1.</b></p> <p>Before mounting the sensor, choose correct location in the room following the next recommendations:</p> <ul style="list-style-type: none"> <li>• 1,5 m minimum height from the floor surface.</li> <li>• 0,5 m minimum distance to the doors and windows.</li> </ul> <p>Please note, avoid placing the sensor in direct sunlight!</p>	
<p><b>Step 2.</b></p> <p>Remove the battery insulation plastic once the sensor is mounted on the wall. The LED will be flashing after power up.</p>	

**Step 3.**

Click the Gateway tile, then 'Add subdevice' and choose the Danfoss Ally™ Room Sensor from the list. Follow the instructions to finish the installation process. Please note, when the sensor is successfully added, immediately assign it to the certain room before finishing the installation!

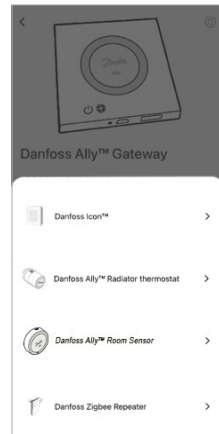

**Step 4.**

Press and hold the installation button for at least 5 sec. to start connection process. Reset of the room sensor is done in the same way.

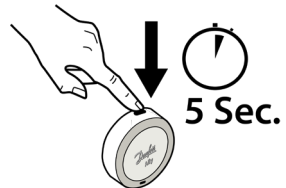

## 11. Danfoss Ally™ Boiler Relay

Danfoss Ally™ Boiler Relay is the ideal accessory to optimize energy efficiency in boiler systems, by ensuring that the boiler is only active when there is an actual heat demand. The Danfoss Ally™ Boiler Relay is a Zigbee certified product, compatible with the Danfoss Ally™ Gateway and with the third party certified systems, using a Zigbee technology.



### 11.1 Facts about the Danfoss Ally™ Boiler Relay:

- Danfoss Ally™ Boiler Relay will activate or deactivate the boiler, depending on the heat demand. This assures that the boiler will only be running when there is a heat demand.
- Controlled from the Danfoss Ally™ App.
- Zigbee 3.0 certified.

Product	Installation Guide – Languages	Code no.
Danfoss Ally™ Boiler Relay	EN, DE, DK, FR, IT, PL, CZ, UA, SE, ES	014G2479

### 11.2 Technical Specifications

Danfoss Ally™ Boiler Relay	
Power supply	Input: Mains 230V~ 50/60 Hz
Output	Volt free 3(1)A at 250V~
Operating temperature range	0 °C to 40 °C
Terminals	Max 2.5 mm <sup>2</sup> wires
Control pollution situation	Degree 2
Controller type	1B
Software class	A
Over voltage category	III
Temperature for Ball pressure test	75 °C
Approvals, markings etc.	

## 12. Danfoss Ally™ Protect RA

Danfoss Ally™ Protect RA is an accessory which protects and increases the strength of the electronic radiator thermostat. The accessory prevents users from removing the batteries inside the electronic radiator thermostat or unmount electric radiator thermostat itself without a tool. Danfoss Ally™ Protect RA gives access to the electronic radiator thermostat display and handle, allowing the user to interact with the electronic radiator thermostat unless these features are disabled through the gateway. Danfoss Ally™ Protect RA is composed of 2 plastic parts (and a M3 screw) and can be used with both the Danfoss Ally™ Electronic Radiator Thermostat and the Danfoss Eco™, as well as in a combination



with the Danfoss Ally™ Power Module 24V. Danfoss Ally™ Protect RA does not affect temperature measurement or other performance of the electronic radiator.



*NOTE: Danfoss Ally™ Protect RA will fit only Radiator Thermostats with RA valve.*

### 12.1 Installation

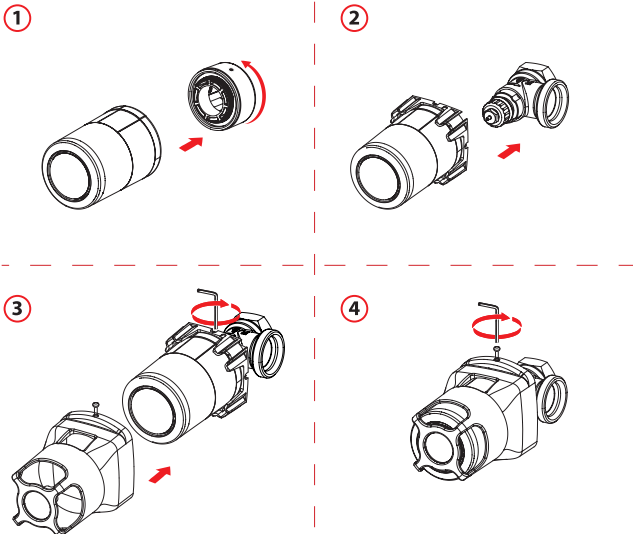
*NOTE: Please, connect the Danfoss Ally™ Radiator Thermostat to the Ally™ Gateway, before mounting Danfoss Ally™ Protect RA.*



## 12.2 Technical Specifications

Danfoss Ally™ Protect RA	
Product type	Tamper proof shell
Recommended use	For electronic thermostatic radiator valve controllers
Adaptor mounting	Compatible with a standard RA adaptor
Lifetime	Mount / Dismount around 10 times in a lifetime
Bending strength	500N or 50 kg
Color	RAL 7035
Type of materials (Base/Shell/Screw)	ABS / ABS / Steel, zinc blue plated
Weight	47 g
Size	100x60 mm
Approvals, markings etc.	  

## 13. Danfoss Ally™ Power Module 24V

Danfoss Ally™ Power Module 24V is an accessory that connects the electronic radiator thermostat to a 24V power system in the building and enables the device to work without batteries. The power output must be a 24 V supply from a safe source with a class II insulation level (Power supply with built-in double or reinforced insulation level between the supply voltage and safe voltage).





Danfoss Ally™ Power Module 24V can be used with both Danfoss Ally™ electronic Radiator Thermostats and Danfoss Eco™, as well as in combination with the Danfoss Ally™ Protect RA for electronic radiator thermostats. Danfoss Ally™ Power Module 24V does not affect the efficiency of the Danfoss electronic radiator thermostats.

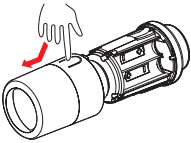
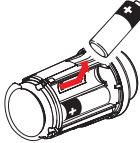
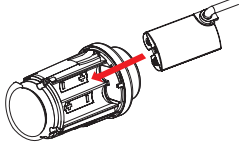
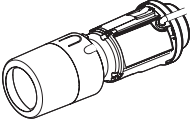
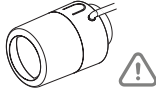
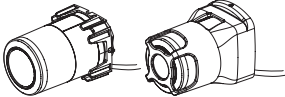

### 13.1 Installation

<p><b>1</b> Remove the cover</p> 	<p><b>2</b> Remove the batteries (if fitted)</p> 	<p><b>3</b> Insert the Danfoss Ally™ Power Module 24V in the same place</p> 
<p><b>4</b> Use the cover provided in the box</p> 	<p><b>5</b> Connect the cable to the existing 24 V supply from a safe source with class II insulation level (see quick guide attached for details)</p> 	<p><b>6</b> When using Danfoss Ally™ Protect RA it is important to install Danfoss Ally™ Power Module 24V before completing the installation of Danfoss Ally™ Protect RA. The cable should go inside one of the cable tracks.</p> 

### 13.2 Technical Specifications

Danfoss Ally™ Power Module 24V	
Power supply	Input: 24V~ or 24V $\overline{\overline{\overline{\quad}}}$ SELV +/-25
	Output: 3V $\overline{\overline{\overline{\quad}}}$ -5%/+25%
Power cable	2 m 0.75 mm <sup>2</sup> H05VVH2-F
Ambient temperature range	0 to 40 °C
Transportation temperature range	-20 to 65 °C
Safety classification	Type 1
Pollution degree 2	PD2
Overvoltage category I	OVI 1,5 kV
Color	RAL 9016
Weight	100 g
IP class	20 (not to be used in hazardous installations or in places where it will be exposed to water)
Approvals, markings etc.	   

## 14. Danfoss Icon™/Icon 2™ – Room Thermostats for Floor Heating

There are many great occasions to upgrade your underfloor heating control. When you swing the paintbrush and lack the final finish.

When you are tired of the heat being unevenly distributed in your home. Or when you just want more comfort and greater savings. Danfoss Icon™ does it all. Quite simple.



### 14.1 Facts about Danfoss Icon™/Icon2™

- All homes can get smart underfloor heating with Danfoss Icon™/Danfoss Icon2™ no matter what system you have today.

All underfloor heating products can be changed to Danfoss Icon™/Danfoss Icon2™ with all the new functions that modern underfloor heating control can offer. Only electronic components need to be replaced and the installer can do it in just a few hours. There are no floors to break up and no water to be drained from the system.



- Full control – even when you are on the go.

Everything else in your home is “smart”. From sound systems to refrigerators. Shouldn't your underfloor heating control be smart too? With Danfoss Icon™/Danfoss Icon2™ the control of the temperature, holiday modes and everyday comfort is safely stored in your own pocket – even when you are on the go. All of this intuitive control is just one download away from landing in your pocket.



- With Danfoss Icon™/Danfoss Icon2™ it is easier to save on the heating bill.

According to the Danish Technological Institute, you save approx. 5% energy for each degree you turn down. Danfoss Icon™/Danfoss Icon2™ automatically regulates so that only the absolutely necessary energy is used to achieve the desired comfort. Therefore, with Danfoss Icon™/Danfoss Icon2™ you can lower the temperature a little without losing comfort and thus save energy.



- Increases the comfort level in your home.

Do you have rooms that do not get enough heat? Or is the heat distributed unevenly?

Danfoss Icon™/Danfoss Icon2™ has automatic balancing. This means that all rooms get exactly the heat they are set for. And pre-setting is not necessary.



### 14.2 Danfoss Icon™ Specifications

Danfoss Icon™ comes in 2 modular concepts, that fit the Ally™ system – Wireless and 24V.

	Wireless	24V
<b>Thermostat models</b>	Display + Display infrared + Dial	Display
<b>Thermostat versions</b>	On-wall	On-wall + In-wall
<b>Exchangeable frame</b>	<b>X</b>	In-wall
<b>Icon App</b>	✓	✓
<b>Cooling options</b>	Automatic + Manual	Automatic + Manual
<b>Automatic balancing</b>	✓	✓
<b>Supply temp. control</b>	✓	✓
<b>Commissioning test</b>	✓	✓
<b>Communication</b>	Wireless 2-way	Star / daisy chain bus
<b>Zones</b>	Up to 3x 15 = 45	Up to 3x 15 = 45



### 14.3 How to install Danfoss Icon™



Danfoss Icon™ Display is a room thermostat especially designed for floor heating systems. It comes in four different designs to suit markets worldwide. Danfoss Icon™ Display is very intuitive and easy to use. Just set your desired comfort temperature, and the thermostat will control the room temperature in accordance with your setting.

#### Wake up the thermostat

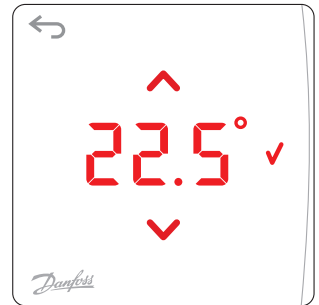
Touch the screen to wake up Danfoss Icon™ Display. The actual room temperature is displayed. Touch  to return to the previous screen. The screen turns off after 10 seconds without any action.



#### Set the temperature

Touch  or  to set the desired room temperature. The temperature flashes to indicate setting is in progress. Confirm your setting by touching .



### 14.4 Connecting Danfoss Icon™ to Danfoss Ally™

Before you try to connect them, please mount all wires and install all thermostats to the Icon™ system! The zigbee Module must be connected before power the Master Controller.

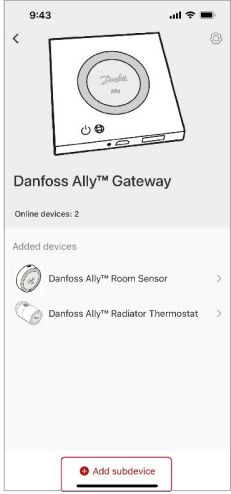
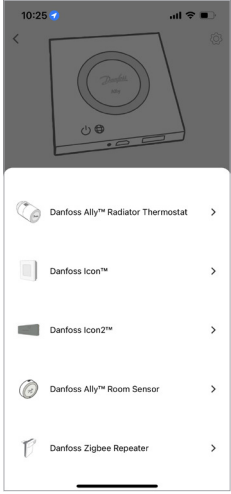
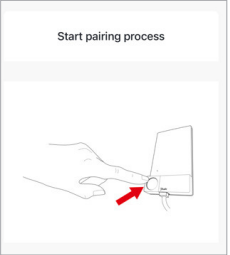
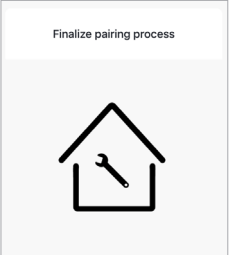
Step 1.	Step 2.	Step 3.	Step 4.
<p>In the Ally™ application, click on your Gateway tile, then 'Add subdevice'.</p> 	<p>Choose Danfoss Icon™ from the list.</p> 	<p>Start the pairing process. When powered, the led will be flashing green slowly to indicate it is ready for pairing. Press the button on the Zigbee module to continue pairing process.</p> 	<p>Finalize pairing process. The LED will be flashing quickly during the pairing process. Locate and select the Icon™ Zigbee module in the 'search device' screen to finalize pairing process. When Zigbee module is paired to the Ally™ Gateway, the LED will be on for 2 minutes.</p> 

### Danfoss Icon™ E-error codes description

Alarm code	Problem	Solution
Er03	You have set-up a cooling application that requires a reference room thermostat to be appointed.	Please go to the thermostat in the desired reference room and enter the thermostat installer menu. Set thermostat to <b>ON</b> in ME.6 “reference room thermostat”.
Er05	Communication lost to Radio Module.	Please check that the cable is properly connected in the Radio Module and Danfoss Icon™ Master Controller 24V.
Er06	Communication lost to room thermostat.	Identify the room thermostat by looking at the flashing outputs on the Danfoss Icon™ Master Controller 24V, or look at the thermostats. Wake up thermostat, then press  on the thermostat. Faling thermostat will say “NET ERR”. In some cases it is necessary to add a repeater to establish a better wireless communication between the Master Controller and Thermostat. Replace batteries on room thermostat and perform a network test (activate NET TEST in menu ME.3 on room thermostat).
Er07	Communication lost to Slave Controller.	If wireless, check Radio Module connection to Danfoss Icon™ Master Controller 24V. If wired system, check the wire connecting the controllers.
Er08	Communication lost from Slave to Master Controller.	If wireless, check Radio Module connection to Danfoss Icon™ Master Controller 24V. If wired system, check the wire connecting the controllers.
Er10	Communication lost to Repeater.	Check that the repeater is plugged into outlet / has not been removed and outlet is <b>ON</b> .
Er11	Communication lost to Expansion Module.	Check that Expansion Module is slidded fully into place. <i>NOTE! The Master controller must be turn off and on again in order to register the expansion module.</i>
Er12	Actuator defective. The defective actuator output is flashing.	Replace actuator.
Er14	A Danfoss Icon™ Master Controller cannot be included as (become) a Slave Controller because one or more room thermostats, repeaters or Danfoss Icon™ Master Controller 24V have already been included.	This Danfoss Icon™ Master Controller 24V has to be factory reset to become a Slave Controller. (See description in chapter “Reset or replace a Danfoss Icon™ Master Controller”).

Alarm code	Problem	Solution
Er16	This application requires a specific actuator output to be available.	You have already assigned this output to a room thermostat, or the output has not yet had an actuator fitted. Please uninstall RT from TWA, it must be available to the application chosen (or fit actuator – if this was not yet done).
Er17	External PT1000 sensor not fitted, or defective.	Check sensor and replace if necessary <i>NOTE! Remember to ensure that the Master Controller is connected due to risk of electric shock.</i>

### 14.5. Frequently asked questions on Danfoss Icon™ section:

- **How do I activate pairing mode Danfoss Icon™ Zigbee Module?**

Pairing mode is activated by short pressing the button. The GREEN LED must be rapidly flashing while the Danfoss Icon™ Zigbee Module is searching for the Danfoss Ally™ Gateway. If the green LED is not rapidly flashing, then factory reset should be performed:

1. Remove the LAN cable from the Danfoss Icon™ Zigbee Module
2. Press and hold the button while connecting the LAN cable again
3. Hold the button until constant red LED and release the button.

Short press the button should then make green LED rapidly flashing.

Please note that the Danfoss Ally™ Gateway might need up to 60 seconds to discover the device.

- **Why is the LED is flashing red on my Danfoss Zigbee repeater?**

Danfoss Zigbee repeater is designed to extend the wireless range from the Danfoss Ally™ Gateway to the Danfoss Ally™ Radiator thermostats or Danfoss Icon Zigbee module. If the Danfoss Zigbee repeater is placed in a location where it is not active – meaning none of the devices are communicating through the repeater then the LED will start flashing to indicate it is not being used. Try moving the repeater to a different location.

For more FAQs and information about the Danfoss Icon™ please, visit our [support page](#).

### 14.6 Danfoss Icon2™ Specifications

Danfoss Icon2™ comes in 3 modular concepts to cover every application – Wireless, common and wired solution.

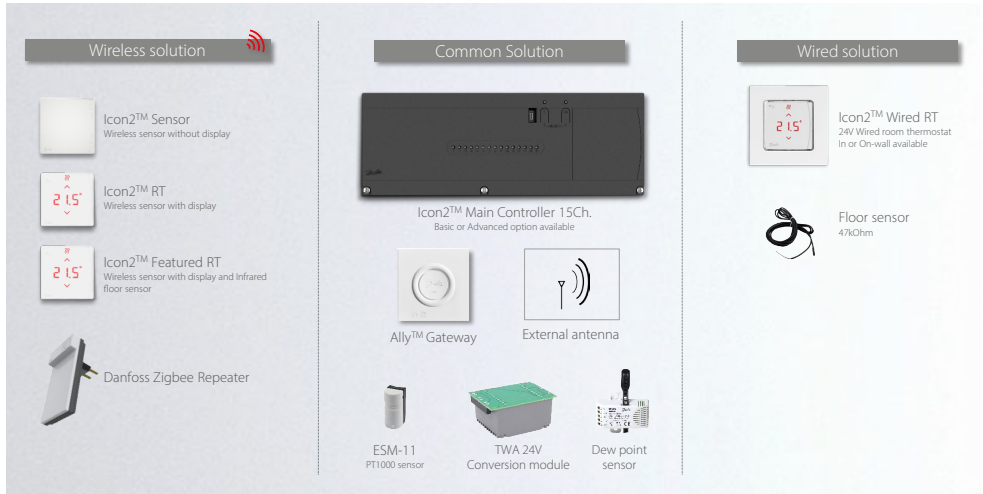

With Danfoss Icon2™ you can chose between 3 different Wireless Thermostats.



Danfoss Icon2™ Sensor



Danfoss Icon2™ RT Display



Danfoss Icon2™ RT Featured

Code number	Version	Display	Humidity sensor	Floor sensor	Tool-free mounting	Open Zigbee
088U2120	Danfoss Icon2™ Sensor	÷	+	÷	+	+
088U2121	Danfoss Icon2™ RT	+	+	÷	+	+
088U2122	Danfoss Icon2™ Featured RT	+	+	+	+	+

Available +

Optional (+)

Not available ÷

For the Danfoss Icon2™ Wired Thermostat you can chose between 4 different versions.



Icon™ 24V RT

Code number	Version	Display	Humidity sensor	Floor sensor	In-wall mounting	Switchable frames
088U2125	Danfoss Icon2™ 24V RT, In-wall 80x80	+	÷	(+)	+	+
088U2126	Danfoss Icon2™ 24V RT, In-wall 86x86	+	÷	(+)	+	+
088U2127	Danfoss Icon2™ 24V RT, In-wall (Feller)	+	÷	(+)	+	+
088U2128	Danfoss Icon2™ 24V RT, On-wall	+	÷	(+)	÷	÷

Available +

Optional (+)

Not available ÷

### Danfoss Icon2™ Main Controller Basic and Advanced Features

Feature	Icon2™ MC Basic	Icon2™ MC Advanced
“Ease of installation” features	+	+
Wireless and Wired thermostats	+	+
Floor temperature control	+	+
Multiple heat emitter control	+	+
Zigbee compatibility to Ally™ and 3rd parties	+	+
Setup and commissioning via Commissioning App	+	+
Handover report via commissioning app	+	+
Multiple Main Controllers connected	+	+
Automatic Hydronic Balancing	+	+
HP optimizer function	+	+
Manual floor cooling	+	+
Advanced floor cooling applications	÷	+
Flow temperature control applications	÷	+

NOTE: To get more information about how to install Danfoss Icon2™ MC and powerline diagrams please, use the installer app as a guideline for installation. Please find “Installer app” from Danfoss on Google Play and App store.

### Danfoss Icon2™ RT Settings

- ME.1** Range limitation
- ME.2** Product ID number  
001-099 range: 230V Display  
100-199 range: 230V Prog.  
201-300 range: 24V Display  
401-500 range: Wireless display  
601-700 range: Wireless IR
- ME.3** Signal strength
- ME.4** Floor sensor usage  
Comfort / Floor / Dual emitters
- ME.5** Floor temperature settings  
Tmin / Tmax
- ME.6** Set thermostat to reference room (cooling C/O, appl. 5-10)
- ME.7** Enable/Disable cooling in room (all cooling applications)

Menu		
ME.1		Min. 5°C  Max. 35°C
ME.2		<b>Product ID / Version</b>
ME.3		<b>Link Test</b>
ME.4		
ME.5		Min. 18°C  Max. 35°C
ME.6		<b>Reference Room</b>
ME.7		<b>Cooling ON/OFF</b>

### 14.7 Connecting Danfoss Icon2™ to Danfoss Ally™

Before you try to connect them, please ensure that the Icon2™ system have been fully configured and powered on.

#### Step 1.

In the Ally™ application, click on your Gateway tile, then 'Add subdevice'.

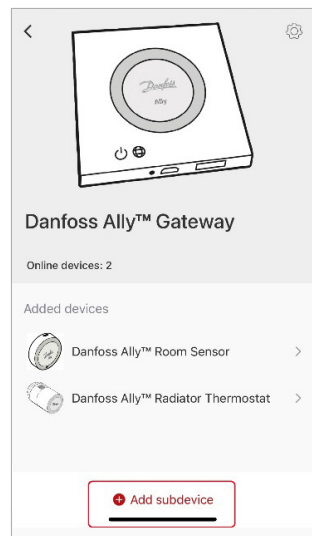

**Step 2.**

Choose Danfoss Icon2™ from the list.

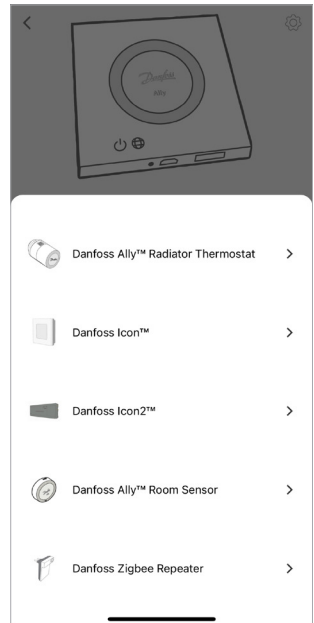

**Step 3.**

Press and hold the 'OK' button to initiate pairing process.

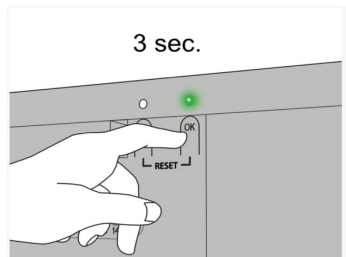

**Step 4.**

The LED above '➤' button will start to blink rapidly while searching for a gateway.

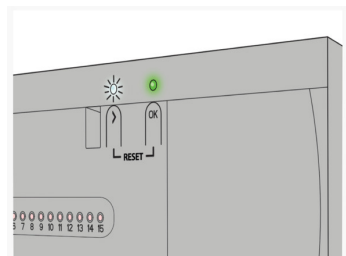



**Step 5.**

When the LED above '>' button is permanently ON, the Danfoss Icon2™ Master Controller is connected to the gateway. Press tick mark button to start pairing process.

*NOTE: The pairing process can take up to 1 minute.*

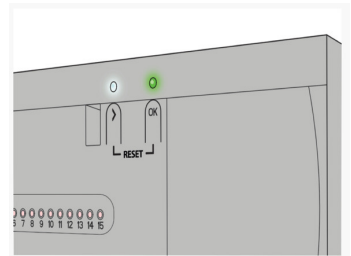

For more information about Danfoss Icon2™, please visit our [support page](#).

You can find all E-error codes on the Installer App. It is available on Google Play Store and App store.

## 15. Data Security

The data security for of the Danfoss Ally™ Gateway and the Danfoss Ally™ App, that is paired to your smartphone is guaranteed.

**Data encryption:** The wireless connection to your Danfoss Ally™ Gateway is protected against threats from unknown devices with the latest encryption technology.

In addition to the security functions that ensure data protection at any point during the data transmission from your smartphone to the Danfoss Ally™ Gateway.

## 16. Safety Precautions

### SIMPLIFIED EU DECLARATION OF CONFORMITY

Hereby, Danfoss A/S declares that the radio equipment type Danfoss Ally™ is in compliance with Directive 2014/53/EU. The full text of the EU declaration of conformity is available at the following internet address: [www.danfoss.com](http://www.danfoss.com)

The gateway is not intended for children and must not be used as a toy. Do not leave packaging materials where children may be tempted to play with them, as this is extremely dangerous. Do not attempt to dismantle the gateway as it contains no user-serviceable parts.

## 17. Disposal

The Danfoss Ally™ Gateway must be disposed of as an electronic waste.





**Danfoss A/S**

Climate Solutions • danfoss.com • +45 7488 2222

---

Any information, including, but not limited to information on selection of product, its application or use, product design, weight, dimensions, capacity or any other technical data in product manuals, catalogues descriptions, advertisements, etc. and whether made available in writing, orally, electronically, online or via download, shall be considered informative, and is only binding if and to the extent, explicit reference is made in a quotation or order confirmation. Danfoss cannot accept any responsibility for possible errors in catalogues, brochures, videos and other material. Danfoss reserves the right to alter its products without notice. This also applies to products ordered but not delivered provided that such alterations can be made without changes to form, fit or function of the product.

All trademarks in this material are property of Danfoss A/S or Danfoss group companies. Danfoss and the Danfoss logo are trademarks of Danfoss A/S. All rights reserved.

---