



Installation and Maintenance Manual

CTC EcoHeat 400

400V 3N~/ 230V 1N~/ 230V 3~



Important!

- Read carefully before use, keep for future reference.
- Translation of the original instructions.

Table of contents

1. Safety instructions	6	12. Pipe installation	83
2. Installation	7	12.1 Filling.....	83
2.1 Transportation	7	12.2 Schematic diagram	84
2.2 Unpacking.....	7	12.3 Heat medium pump (G11)	88
2.3 Recycling	7	12.4 Schematic diagram of passive cooling – Combined cooling/heating	89
2.4 Standard delivery	7	12.5 Schematic diagram of passive cooling in separate heating circuits	90
2.5 Control functions (std.) and with Expansion Card.....	8	13. Connecting the brine system	92
3. Your home's heating installation	10	13.1 Brine system schematic diagram	94
4. Technical data	14	13.2 Brine pump.....	96
4.1 Table 400V 3N~	14	14. Electrical installation	97
4.2 Table 230V 1N~	16	14.1 Positioning of electrical components	99
4.3 Table 230V 3~	18	14.2 Settings to be carried out by the installation electrician ..	100
5. Measurements	20	14.3 Installing a backup power supply.....	101
6. CTC EcoHeat 400 design	22	14.4 Groundwater heating.....	101
7. Parameter list	23	14.5 Connection of pump (G46) to Differential thermostat function	101
8. Control system	24	14.6 Connection of sensor (B46) to Differential thermostat function	101
8.1 Quick start touchscreen	25	14.7 Resistances for sensors.....	102
8.2 Installation wizard.....	27	14.8 Wiring diagram tank 400V 3N~	104
9. Detailed menu descriptions	28	14.9 Wiring diagram tank 230V 1N~	105
9.1 Start menu.....	28	14.10 Wiring diagram tank 230V 3~	106
9.2 Alarm management.....	28	14.11 Wiring diagram heat pump 400V 3N~	107
9.3 Heating/Cooling	29	14.12 Wiring diagram heat pump 230V 1N~	108
9.4 DHW.....	33	14.13 Component list, wiring diagram	109
9.5 Ventilation.....	33	15. Installation Communication	110
9.6 Schedule	34	15.1 Installing the network cable	111
9.7 Operation data	36	15.2 Remote - Screen Mirroring	112
9.8 Display	42	15.3 myUplink - App	112
9.9 Settings	44	16. First start	113
9.10 Define	60		
9.11 Service	72		
10. Operation and Maintenance	76		
11. Troubleshooting/Appropriate measures	77		
11.1 Information messages.....	79		
11.2 Alarm messages	80		

Software update



software.ctc.se

EN

For more information on updated functions and downloading the latest software, see the website "software.ctc.se".

Removing the cooling module



- Any work done on the product's cooling system should be done by authorised personnel only.
- Close the safety switch before doing any work on the product.

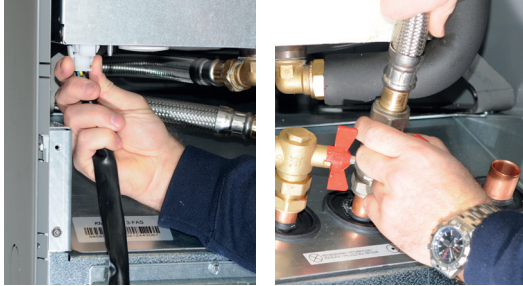

1. Disconnect the cooling module's power cable connector and hoses.



2. Attach the two carrying handles to the bottom of the cooling module.



3. Unscrew the cooling module's screws.
4. Fold out the front cable harness and loosen the flat pin on the red EMC cable.



5. Pull the cooling module by first lifting the front edge slightly with the carrying handles.



6. Lift the cooling module using the carrying handles and shoulder straps.

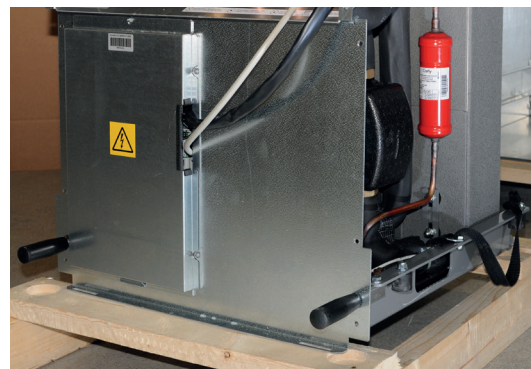

7. Lift the cooling module into the product using the carrying handles and shoulder straps. Remove the carrying handles and reconnect the power cable, hoses and screws.
8. Before the cooling module is tightened into position, ensure the EMC cable is affixed.

Congratulations on your new product!



You have just purchased a CTC EcoHeat 400, with which we hope you will be very pleased. Read about how you can take care of your heat pump on the following pages. One chapter is written for the property owner and one chapter for the installer.

Save this manual containing the installation and maintenance instructions. If it is looked after properly, you will be able to enjoy the use of your CTC EcoHeat 400 for many years. This manual will provide all the information you will need.

The complete heat pump

CTC EcoHeat 400 is a complete heat pump which meets your home's heating and DHW requirements. It is equipped with a motorised mixing valve which ensures that correct and even temperatures are supplied to your heating circuit. In addition, CTC EcoHeat 400 has a built-in circulation pump for connection to ground/bedrock coils, i.e the 'cold side'. This can be connected to either the left, right or back of the heat pump, whichever suits you best.

! NB: This installation manual contains information about technical data, operation, installation, etc. Local regulations or country-specific regulations must be considered.

CTC EcoHeat 400 has a control system which:

- monitors all heat pump functions
- allows for individual settings;
- Displays desired values, such as temperatures, operation times, energy consumption and fault signals.
- Facilitates the setting of values and troubleshooting in a simple and well-structured way.

The built-in copper coil provides copious amounts of DHW. CTC EcoHeat 400 also has a summertime basement heating function and an underfloor heating blocking function, which maximises the temperature supplied to the floor circuits. Using the integrated night reduction function, you can set and change the temperature in the house during the day, from one day to the next.

Easily accessible electrical components, along with effective troubleshooting functions in the control program, make the CTC EcoHeat 400 easy to service. It comes with a room sensor as standard, which is equipped with an LED that flashes in the event of a fault.

If you want to supplement your CTC EcoHeat 400 with other heating, you can do this easily thanks to two unique connections. We have decided to call this option Energyflex. With Energyflex you can, for example:

- Charge your heating circuit with solar energy.
- Allow a water-jacketed stove to contribute heat.
- Connect a pool heat exchanger to heat up a swimming pool.

Important to remember!

Check the following points at the time of delivery and installation:

- The product must be transported and stored in an upright position. When moving the product, it can be placed temporarily on its back.
- Remove the packaging and check before installation that the product has not been damaged in transit. Report any transport damage to the carrier.
- Place the product on a solid foundation, preferably made of concrete. **If the product is to stand on a soft carpet, plates must be placed under the feet.**
- Remember to leave a service area of at least 1 metre in front of the product.
- The product must not be placed below floor level either.
- Avoid placing EcoHeat in rooms with lightly insulated walls where neighbouring rooms may be disturbed by the compressor and vibrations.
- Register the product for warranty and insurance via the website <https://www.ctc-heating.com/customer-service#warranty-registration>

! If these instructions are not followed during the installation, operation and maintenance of the system, Enertech's liability under the applicable warranty terms is not binding.

i Information in this type of box [i] is intended to help ensure that the product functions optimally.

! Information in this type of box [!] is particularly important for correctly installing and using the product.

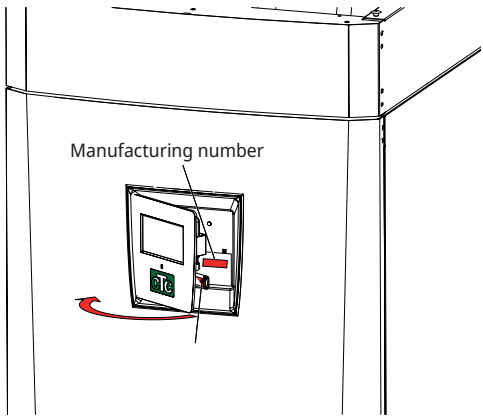

For your own reference

Fill in the information below. It may come in useful if anything should happen.

Product:	Serial no.:
Installer:	Name:
Date:	Tel. no.:
Electrical installer:	Name:
Date:	Tel. no.:

No liability is accepted for any misprints. We reserve the right to make design changes.

1. Safety instructions



Turn off the power with an omnipolar switch before doing any work on the product.



The product must be connected to protective earth.



The product is classified as IPX1. The product must not be rinsed with water.



When handling the product with a hoist ring or similar device, make sure that the lifting equipment, eyebolts and other parts are not damaged. Never stand under the hoisted product.



Never jeopardise safety by removing bolted covers, hoods or similar.



Any work on the product's cooling system should be carried out by authorised personnel only.



Installation and connection in the product must be carried out by a authorised electrician. All piping must be installed according to the applicable requirements.

Service of the product's electrical system must only be carried out by a qualified electrician in compliance with the specific requirements of the national standard for electrical safety.

Replacement of damaged supply cable, must be carried out by the manufacturer or qualified service engineer to avoid risk.



Safety valve check:
-Safety valve for boiler/system to be checked regularly.



The product must not be started if it is not filled with water; instructions are in the "Pipe installation" section.



WARNING: Do not switch on the product if there is a possibility that the water in the heater is frozen.



This device can be used by children from the age of eight years and above and by people with reduced physical, sensory or mental ability or lack of experience or knowledge if they have been taught, either with supervision or with the instructions provided, how to use the device safely and understand the risks involved. Children should not play with the device. Cleaning and maintenance should not be carried out by children without supervision.



If these instructions are not followed when installing, operating and maintaining the system, Enertech's commitment under the applicable warranty terms is not binding.

2. Installation

This section is aimed at anyone responsible for one or more of the installations required to ensure that the product works the way the property owner wants.

Take your time going through functions and settings with the property owner and answer any questions. Both you and the heat pump benefit from a user who has completely understood how the system operates and should be maintained.

2.1 Transportation

Transport the unit to the installation site before removing the packaging. Handle the product in the following manner:

- Forklift.
- Lifting eye that has been fitted to the lifting sleeve on top of EcoHeat. An extra sleeve can be found in the middle, under the insulation.
- Lifting band around the pallet. **NB:** Can only be used with the packaging on.

Remember that the heat pump has a high centre of gravity and should be handled with caution.

2.2 Unpacking

Unpack the heat pump when it is placed next to its installation site. Check that the product has not been damaged in transit. Report any transport damage to the carrier. Also check that the delivery is complete according to the list below.

2.3 Recycling

- The packaging must be deposited at a recycling station or with the installation engineer for correct waste management.
- Obsolete products must be disposed of correctly and transported to a waste station or distributor/retailer offering this service. Disposal of the product as household waste is not permitted.
- It is very important that the product's refrigerant, compressor oil and electric/electronic components are disposed of correctly.

2.4 Standard delivery

- CTC EcoHeat 400 heat pump
- Connection pipe for cold side
- Filler manifold
- Connected electrical cabling
 - 3 m supply cable, of which 1.1 m is inside the product
 - 2.5 m primary/return sensor (NTC 22k)
- Packaging contains:
 - room sensor
 - outdoor sensor, cable length 15 m
 - installation and maintenance manual
 - safety valve for drinking water, 9 bar
 - safety valve for cold side, 3 bar
 - 2 x cable ties
 - 3 x support sleeves
 - brine level vessel
 - 3 x current sensors
 - Ferrit 25 MHz, 141 ohm

 The product must be transported and stored in an upright position.

 Since the cooling module is removable, there must be a free space of at least one metre in front of the product and it must not be installed below floor level.

2.5 Control functions (std.) and with Expansion Card

The product is supplied from the factory with control functions according to "Basic functions" below.

Supplementing with the expansion card accessory (A3) adds solar control and its variants as well as bore hole recharging and various tanks. In addition, DHW circulation and pool control are also included.

Basic functions

(built into the factory version)

- Heating circuit 1
- Heating circuit 2*
- Diff thermostat*
- Passive cooling*
- CTC SMS*
- Remote control
- SmartGrid

Functions with expansion card (A3)

(accessory)

- Solar control
- DHW circulation
- Pool

* Requires accessories such as: Extra sensor, mixing valve group 2, etc.

Checklist

The checklist must always be completed by the installation engineer

- If a service is performed, you may be required to provide this document.
- Installation must always be done according to the installation and maintenance instructions.
- Installation must always be carried out in a professional manner.
- Following installation, the unit should be inspected and checked for functionality.

The points below must be checked off:

Pipe installation

- Heat pump filled, positioned and adjusted in the correct manner according to the instructions.
- The heat pump is positioned so that it can be serviced.
- The radiator pump's capacity for the required flow.
- Open radiator valves and other relevant valves.
- Tightness test.
- Bleed the system.
- Safety valve function test.
- Waste pipe connected to floor drain.

Electrical installation

- Compressor, direction of rotation.
- Safety switch.
- Correct and taut wiring.
- Requisite sensors for selected system.
- Outdoor sensor.
- Room sensor (optional).
- Heat pump activated and started.
- Electric power and fuse, adapted for the property, BBR, in normal operation and with backup power supply.

Customer information (adapted to the relevant installation)

- Start-up with customer/installer.
- Menus/controls for selected system.
- Installation and Maintenance Manual handed over to the customer.
- Check and filling, heating circuit.
- Fine-tuning information, heat curve.
- Alarm information.
- Mixing valve.
- Safety valve function test.
- Register your Installation Certificate at ctc-heating.com.
- Information on fault reporting procedures.

Date/Customer

Date/Installer

3. Your home's heating installation

The House Heating Curve

The heating curve is the central part of the product's control system. It is the heating curve which determines the compensated flow temperature requirements for your property dependent upon the outdoor temperatures. It is important that the heating curve is correctly adjusted, so that you achieve the best operation and economy possible.

One property requires a radiator temperature of 30 °C when the outdoor temperature is 0 °C, whilst a different property requires 40 °C. The difference between different properties is determined by the radiator surface area, the number of radiators and how well insulated the house is.

Adjusting the heating curve

In the "Heating curve" menu under "Settings/Heating circuit", you can fine adjust the values of the heating curve for the primary flow temperature in relation to the outdoor temperature in the graph, as well as set the values for curve inclination and curve adjustment for the heating circuit.

See section "Heating curve" in chapter "Settings/ Heating circuit" for detailed information.

Ask your installer to help you set these values.

It is extremely important to set the heating curve and, in some cases, unfortunately, this process may take several weeks. The best way of doing this, upon the initial start-up, is to select operation without any room sensor. The system then operates using the outdoor temperature reading and the property's heating curve only.

During the adjustment period it is important that:

- the night reduction function is not selected.
- all thermostat valves on the radiators be fully opened. (This is to find the lowest curve for the most economical use of the heat pump).
- the outdoor temperature is not higher than +5 °C.
- the radiator system is operational and correctly adjusted between different circuits.

For more information on how to set the heating curve, see section "Heating curve" in chapter "Settings / Heating circuit".

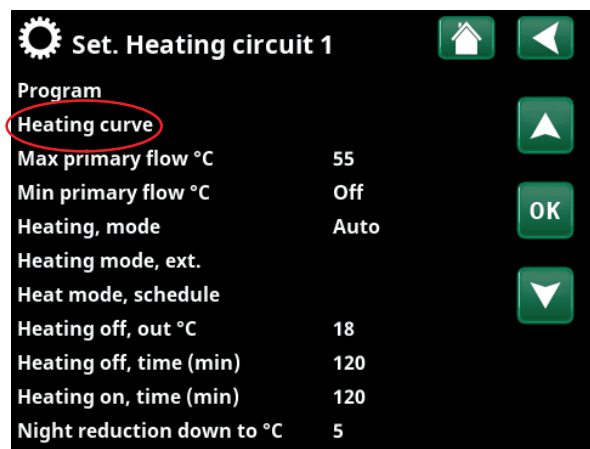

Part of the "Installer/Settings/Heating Circuit/Heating Circuit 1" menu.

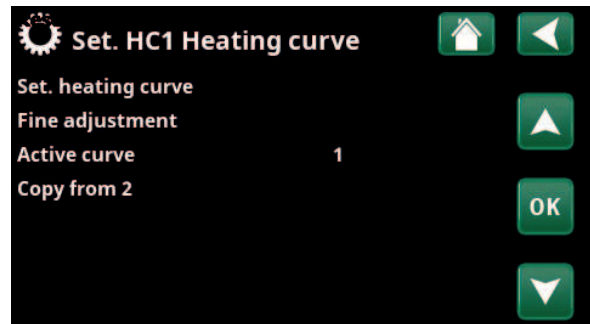

Menu: "Installer / Settings / Heating Circuit / Heating Circuit 1/Heating curve". Active curve: #1.

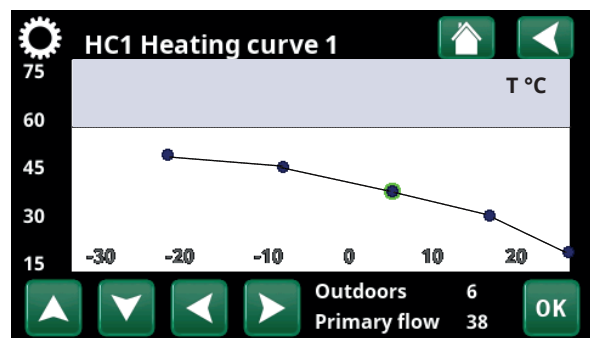

Menu: "Installer / Settings / Heating Circuit / Heating Circuit 1/Heating curve/Fine adjustment".

Appropriate Default Values

During installation you can seldom achieve a precise setting for the heating curve instantly. In this case, the values given below may provide a good starting point. Radiators with small heat-emission surfaces require a higher primary flow temperature. You can adjust the gradient (heating curve gradient) for your heating system under the "Installer/Settings/Radiator system" menu. Recommended values are:

Floor heating only:	Inclination 35
Low temperature system: (well insulated houses)	Inclination 40
Normal temperature system: (factory setting)	Inclination 50
High temperature system: (older houses, small radiators, poorly insulated)	Inclination 60

Adjusting the heating curve

The method described below can be used to adjust the heating curve correctly.

Adjustment if it is too cold indoors:

- If the outdoor temperature is **lower** than 0 degrees:
Increase the Inclination value by a couple of degrees.
Wait 24 hours to see if any further adjustment is required.
- If the outdoor temperature is **higher** than 0 degrees:
Increase the Adjustment value by a couple of degrees. Wait 24 hours to see if any further adjustment is required.

Adjustment if it is too warm indoors:

- If the outdoor temperature is **lower** than 0 degrees:
Decrease the Inclination value by a couple of degrees.
Wait 24 hours to see if any further adjustment is required.
- If the outdoor temperature is **higher** than 0 degrees:
Decrease the Adjustment value by a couple of degrees.
Wait 24 hours to see if any further adjustment is required.



The set heating curve always takes priority. The room sensor can only increase or decrease the heat beyond the set heating curve to a certain extent. Where operating without a room sensor, the selected heating curve determines the flow temperature supplied to the radiators.

Examples of Heating Curves

You can see in the diagram below how the heating curve changes with different Inclination settings. The gradient of the curve shows the temperatures that the radiators require at different outdoor temperatures.

Curve Inclination

The inclination value which is set is the primary flow temperature when the outside temperature is -15°C .

Adjustment

The curve can be parallel displaced (adjusted) by the desired number of degrees to adapt to different systems/ houses.

Inclination 50°C
Adjustment $+5^{\circ}\text{C}$

Inclination 50°C
Adjustment 0°C

An example

Inclination 60°C
Adjustment 0°C

In this example, the maximum outgoing primary flow temperature is set at 55°C .
The minimum permitted primary flow temperature is 27°C (e.g. summer-time basement heating or the floor circuits in a bathroom).

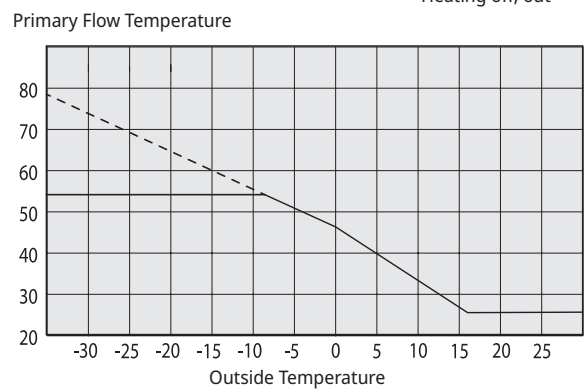
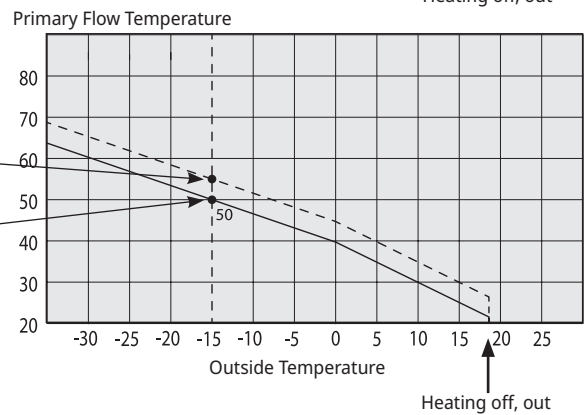
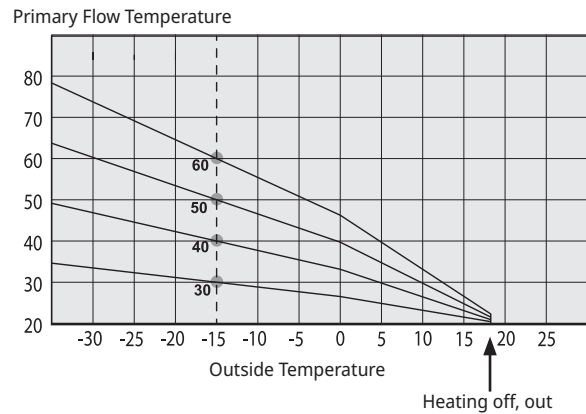

If the values set are too low, this may mean that the desired room temperature is not being reached. You then need to adjust the heating curve, as necessary, following the method shown above.

Summer season

All properties have internal heat gains (lamps, oven, body heat, etc.), which means that the heating can be switched off when the outdoor temperature is lower than the desired room temperature. The better insulated the house is, the earlier the heating from the heat pump can be switched off.

The example shows the product set at the default value of 18°C. This value, **"Heating off, outside"**, can be changed in the "Installer/Settings/Heat circuit" menu.

In systems with a radiator pump, the radiator pump stops when the heat is switched off. The heating starts up automatically when it is required again.

See chapter "Settings/Heating circuit" for information on setting the heating mode.

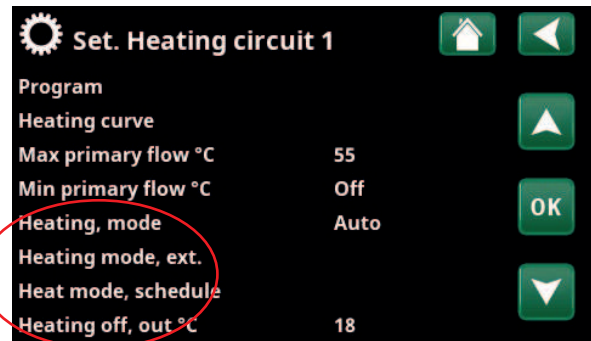
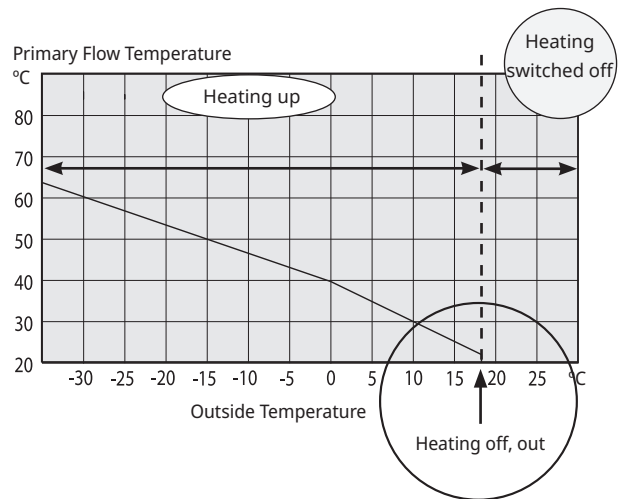

Part of the "Installer/Settings/Heating Circuit/Heating Circuit 1" menu.

4. Technical data

4.1 Table 400V 3N~

Electrical Data		EcoHeat 406	EcoHeat 408	EcoHeat 410	EcoHeat 412
Electrical data		400V 3N~ 50 Hz			
Rated power	kW	11.7	12.5	13.2	14.1
Max starting current	A	16.6	17.7	19.8	23.5
Electric heater (steps of 0.3 kW)	kW	0.3 - 9.0			
Max. Electric heater output @ fuse size 10 A/ 13 A/ 16 A/ 20 A/ 25 A	kW	2,1/ 2.1/ 6.9/ 9.0/ 9.0	0.9/ 2.1/ 6.9/ 7.8/ 9.0	0.9/ 2.1/ 2.1/ 7.8/ 9.0	-/ 0.9/ 2.1/ 6.9/ 9.0
IP class		IP X1			

Operational data for heat pump		EcoHeat 406	EcoHeat 408	EcoHeat 410	EcoHeat 412
Output from compressor ¹⁾ @ -5/45	kW	4.68	6.84	8.33	9.88
Input power ¹⁾ @ -5/45	kW	1.51	2.04	2.52	2.99
COP ¹⁾ @ -5/45	-	3.09	3.34	3.30	3.30
Output from compressor ¹⁾ @ 0/35 0/45 0/55	kW	5.90 5.48 5.17	8.19 7.87 7.55	9.97 9.55 9.28	11.75 11.24 10.97
Input power ¹⁾ @ 0/35 0/45 0/55	kW	1.29 1.54 1.87	1.79 2.15 2.52	2.17 2.59 3.11	2.55 3.07 3.71
COP ¹⁾ @ 0/35 0/45 0/55	-	4.57 3.54 2.76	4.58 3.64 2.99	4.60 3.68 2.98	4.60 3.66 2.96
Output from compressor ¹⁾ @ 5/35 5/45 5/55	kW	6.81 6.49 6.08	9.44 9.05 8.65	11.42 10.99 10.58	13.53 12.95 12.57
Input power ¹⁾ @ 5/35 5/45 5/55	kW	1.30 1.56 1.91	1.88 2.24 2.62	2.19 2.64 3.23	2.65 3.15 3.75
COP ¹⁾ @ 5/35 5/45 5/55	-	5.24 4.15 3.18	5.02 4.04 3.30	5.20 4.16 3.28	5.11 4.11 3.35
Rated current cooling module	A	4.5	5.2	6.8	8.2

¹⁾ EN14511:2007, incl. heating medium pump and brine pump.

Heating system		EcoHeat 406	EcoHeat 408	EcoHeat 410	EcoHeat 412
Water volume. thermal store (V)	l	223			
Max. operating pressure. thermal store (PS)	bar	3.0			
Max. temperature. thermal store (TS)	°C	100			
Heating system. min. flow	l/s	Unlimited			
Heating system. nominal flow ²⁾	l/s	0.14	0.20	0.24	0.28
Pressure drop for mixing valve heating		See pressure drop diagram in the "Pipe installation" chapter.			

²⁾ $\Delta t = 10$ K and 0/35 °C heat pump operation.

No annual leakage control of the refrigerant is required.

Technical data

Brine system		EcoHeat 406	EcoHeat 408	EcoHeat 410	EcoHeat 412
Water volume (V)	l	2.3	2.9	2.9	3.4
Brine system min./max. temp. (TS)	°C	-5/20			
Brine system min./max. pressure (PS)	bar	0.2/3.0			
Brine system min. flow, $\Delta t = 5 \text{ }^\circ\text{K}$	l/s	0.27	0.31	0.38	0.44
Brine system nominal flow, $\Delta t = 3 \text{ }^\circ\text{K}$	l/s	0.37	0.51	0.64	0.73
Brine pump		Class A circulation pump			
Pump capacity		See diagram in the "Pipe installation" chapter.			

Hot water system		EcoHeat 406	EcoHeat 408	EcoHeat 410	EcoHeat 412
Water volume, hot water coil (V)	l	5.7 Cu (8.5 Inox)			
Max. operating pressure, hot water coil (PS)	bar	10			

Other data		EcoHeat 406	EcoHeat 408	EcoHeat 410	EcoHeat 412
Refrigerant quantity (R407C, fluorinated greenhouse gases GWP 1774)	kg	1.9	1.9	1.9	2.3
CO2 equivalent	ton	3,370	3,370	3,370	4,080
Interrupt value switch HP	MPa	3.1 (31 bar)			
Weight (Inox)	kg	278 (267)	276 (265)	281 (270)	294 (283)
Depth x Width x Height	mm	673 x 596 x 1904			
Minimum ceiling height	mm	1925			
Noise level according to EN 12102 ($L_{WA} / @B0$)	dB(A)	43	46	49	50

No annual leakage control of the refrigerant is required.

4.2 Table 230V 1N~

Electrical Data		EcoHeat 406	EcoHeat 408	EcoHeat 410	EcoHeat 412
Electrical data		230V 1N~ 50 Hz			
Rated power	kW	11.7	12.4	13.4	14.2
Electric heater (steps of 0,3 kW)	kW	0.3 - 9.0			
Max. Electric heater output @ fuse size 20 / 25 / 32 / 35 / 50 / 63 A	kW	1.8/3.0/4.5/ 5.1/8.7/9	0.9/1.8/3.6/ 4.2/7.8/9	-/1.2/3.0/ 3.6/6.9/9	-/0.6/2.1/ 2.7/6.3/9
IP class		IP X1			

Operational data for heat pump		EcoHeat 406	EcoHeat 408	EcoHeat 410	EcoHeat 412
Output from compressor ¹⁾ @ -5/45	kW	4.68	6.84	8.33	9.88
Input power ¹⁾ @ -5/45	kW	1.51	2.04	2.52	2.99
COP ¹⁾ @ -5/45	-	3.09	3.34	3.30	3.30
Output from compressor ¹⁾ @ 0/35 0/45 0/55	kW	5.90 5.48 5.17	8.19 7.87 7.55	9.97 9.55 9.28	11.75 11.24 10.97
Input power ¹⁾ @ 0/35 0/45 0/55	kW	1.29 1.54 1.87	1.79 2.15 2.52	2.17 2.59 3.11	2.55 3.07 3.71
COP ¹⁾ @ 0/35 0/45 0/55	-	4.57 3.54 2.76	4.58 3.64 2.99	4.60 3.68 2.98	4.60 3.66 2.96
Output from compressor ¹⁾ @ 5/35 5/45 5/55	kW	6.81 6.49 6.08	9.44 9.05 8.65	11.42 10.99 10.58	13.53 12.95 12.57
Input power ¹⁾ @ 5/35 5/45 5/55	kW	1.30 1.56 1.91	1.88 2.24 2.62	2.19 2.64 3.23	2.65 3.15 3.75
COP ¹⁾ @ 5/35 5/45 5/55	-	5.24 4.15 3.18	5.02 4.04 3.30	5.20 4.16 3.28	5.11 4.11 3.35
Rated current cooling module	A	14.0	19.5	21.6	27.1

¹⁾ EN14511:2007, incl. heating medium pump and brine pump.

Heating system		EcoHeat 406	EcoHeat 408	EcoHeat 410	EcoHeat 412
Water volume. thermal store (V)	l	223			
Max. operating pressure. thermal store (PS)	bar	3.0			
Max. temperature. thermal store (TS)	°C	100			
Heating system. min. flow	l/s	Unlimited			
Heating system. nominal flow ²⁾	l/s	0.14	0.20	0.24	0.28
Pressure drop for mixing valve heating		See pressure drop diagram in the "Pipe installation" chapter.			

²⁾ $\Delta t = 10$ K and 0/35 °C heat pump operation.

No annual leakage control of the refrigerant is required.

Technical data

Brine system		EcoHeat 406	EcoHeat 408	EcoHeat 410	EcoHeat 412
Water volume (V)	l	2.3	2.9	2.9	3.4
Brine system min./max. temp. (TS)	°C	-5/20			
Brine system min./max. pressure (PS)	bar	0.2/3.0			
Brine system min. flow, $\Delta t = 6 \text{ }^\circ\text{K}$	l/s	0.27	0.31	0.38	0.44
Brine system nominal flow, $\Delta t = 3 \text{ }^\circ\text{K}$	l/s	0.37	0.51	0.64	0.73
Brine pump		Class A circulation pump			
Pump capacity		See diagram in the "Pipe installation" chapter.			

Hot water system		EcoHeat 406	EcoHeat 408	EcoHeat 410	EcoHeat 412
Water volume, hot water coil (V)	l	5.7 Cu (8.5 Inox)			
Max. operating pressure, hot water coil (PS)	bar	10			

Other data		EcoHeat 406	EcoHeat 408	EcoHeat 410	EcoHeat 412
Refrigerant quantity (R407C, fluorinated greenhouse gases)	kg	1.9	1.9	1.9	2.3
CO ₂ equivalent	ton	3.370	3.370	3.370	4.080
Cut-out value pressostat HP	MPa	3.1 (31 bar)			
Weight	kg	278	276	281	294
Width x Height x Depth	mm	597 x 1907 x 673			
Minimum ceiling height	mm	1925			
Noise level according to EN 12102	dB(A)	44.9	43.9	48.5	48.0

No annual leakage control of the refrigerant is required.

4.3 Table 230V 3~

Electrical Data		EcoHeat 406	EcoHeat 408	EcoHeat 410	EcoHeat 412
Electrical data		230V 3N~ 50 Hz			
Rated power	kW	9.8	10.5	11.5	12.4
Electric heater (steps of 1.2 kW)	kW	1.2-7.05			
Max power immersion heater at group fuse 20 A/ 25 A/ 32 A/ 35 A/ 50 A/ 63 A	A	2.3/ 4.7 / 5.8/ 7.0/ 7.0/ 7.0	-/ 3.5/ 4.7/ 5.8/ 7.0/ 7.0	-/ 3.5/ 4.7/ 4.7/ 7.0/ 7.0	-/ NA/ 3.5/ 3.5/ 7.0/ 7.0
IP class		IPX1			

Operational data for heat pump		EcoHeat 406	EcoHeat 408	EcoHeat 410	EcoHeat 412
Output from compressor ¹⁾ @ -5/45	kW	4.68	6.84	8.33	9.88
Input power ¹⁾ @ -5/45	kW	1.51	2.04	2.52	2.99
COP ¹⁾ @ -5/45	-	3.09	3.34	3.30	3.30
Output from compressor ¹⁾ @ 0/35 0/45 0/55	kW	5.90 5.48 5.17	8.19 7.87 7.55	9.97 9.55 9.28	11.75 11.24 10.97
Input power ¹⁾ @ 0/35 0/45 0/55	kW	1.29 1.54 1.87	1.79 2.15 2.52	2.17 2.59 3.11	2.55 3.07 3.71
COP ¹⁾ @ 0/35 0/45 0/55	-	4.57 3.54 2.76	4.58 3.64 2.99	4.60 3.68 2.98	4.60 3.66 2.96
Output from compressor ¹⁾ @ 5/35 5/45 5/55	kW	6.81 6.49 6.08	9.44 9.05 8.65	11.42 10.99 10.58	13.53 12.95 12.57
Input power ¹⁾ @ 5/35 5/45 5/55	kW	1.30 1.56 1.91	1.88 2.24 2.62	2.19 2.64 3.23	2.65 3.15 3.75
COP ¹⁾ @5/35 5/45 5/55	-	5.24 4.15 3.18	5.02 4.04 3.30	5.20 4.16 3.28	5.11 4.11 3.35
Rated current cooling module		14.0	19.5	21.6	27.1

¹⁾ EN14511:2007, incl. heating medium pump and brine pump.

Heating system		EcoHeat 406	EcoHeat 408	EcoHeat 410	EcoHeat 412
Water volume. thermal store (V)	l	223			
Max. operating pressure. thermal store (PS)	bar	3.0			
Max. temperature. thermal store (TS)	°C	100			
Heating system. min. flow	l/s	Unlimited			
Heating system. nominal flow ²⁾	l/s	0.14	0.20	0.24	0.28
Pressure drop for mixing valve heating		See pressure drop diagram in the "Pipe installation" chapter.			

²⁾ $\Delta t = 10$ K and 0/35 °C heat pump operation.

No annual leakage control of the refrigerant is required.

Technical data

Brine system		EcoHeat 406	EcoHeat 408	EcoHeat 410	EcoHeat 412
Water volume (V)	l	2.3	2.9	2.9	3.4
Brine system min./max. temp. (TS)	°C	-5/20			
Brine system min./max. pressure (PS)	bar	0.2/3.0			
Brine system min. flow, $\Delta t = 6 \text{ }^\circ\text{K}$	l/s	0.27	0.31	0.38	0.44
Brine system nominal flow, $\Delta t = 3 \text{ }^\circ\text{K}$	l/s	0.37	0.51	0.64	0.73
Brine pump		Class A circulation pump			
Pump capacity		See diagram in the "Pipe installation" chapter.			

Hot water system		EcoHeat 406	EcoHeat 408	EcoHeat 410	EcoHeat 412
Water volume, hot water coil (V)	l	5.7 Cu (8.5 Inox)			
Max. operating pressure, hot water coil (PS)	bar	10			

Other data		EcoHeat 406	EcoHeat 408	EcoHeat 410	EcoHeat 412
Refrigerant quantity (R407C, fluorinated greenhouse gases GWP 1774)	kg	1.9	1.9	1.9	2.3
CO2 equivalent	ton	3.370	3.370	3.370	4.080
Interrupt value switch HP	MPa	3.1 (31 bar)			
Weight	kg	278	276	281	294
Depth x Width x Height	mm	673 x 596 x 1904			
Minimum ceiling height	mm	1925			
Noise level according to EN 12102 (L_{WA} , @B0)	dB(A)	43	46	49	50

No annual leakage control of the refrigerant is required.

5. Measurements

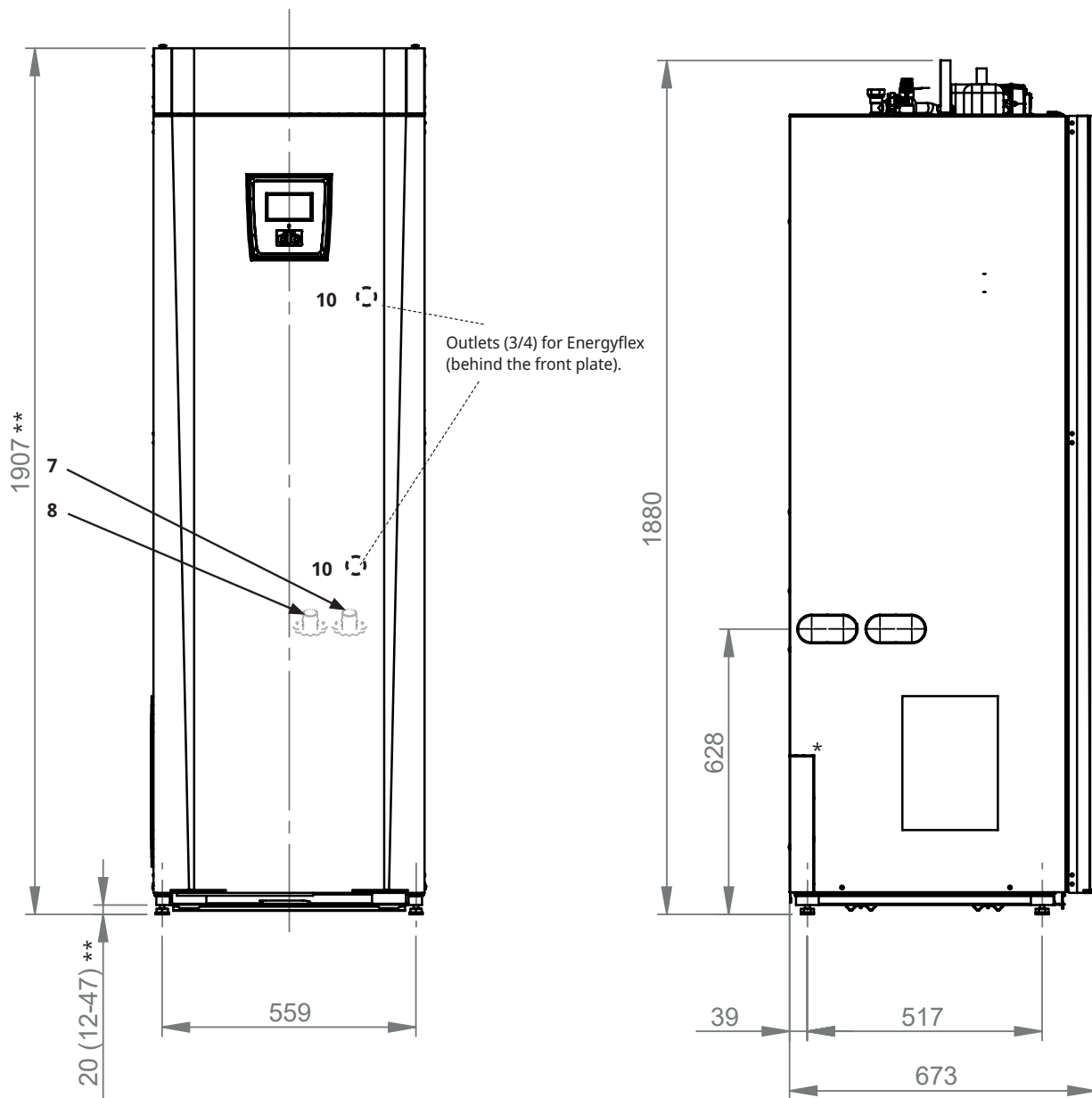

* Perforation of socket outlets is not necessary as the cooling module's sound damper is located directly behind the side panel.

** The product is delivered with the feet adjusted to a height of 1907 mm. The feet enable height adjustment between 1899-1934 mm.

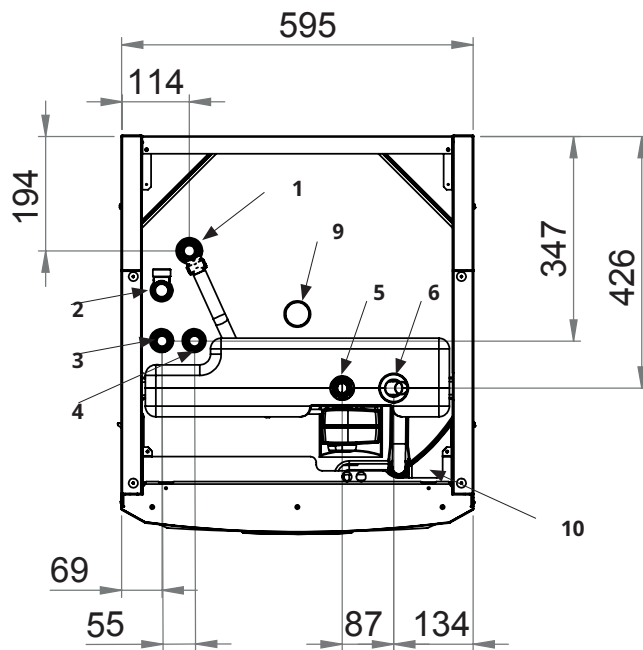

1. Venting clamp ring 22
2. Waste pipe connection clamp ring 3/4"
3. Cold water connection Ø22
4. DHW Ø22
5. Radiator primary flow clamp ring Ø22
6. Radiator return/expansion connection Ø22
7. From ground/bedrock circuit Ø28 (right, left and back)
8. To ground/bedrock circuit Ø28 (right, left and back)
9. Lifting sleeve 3/4" BSP
10. Connection of external systems (pipe lead-through)

6. CTC EcoHeat 400 design

The picture below shows the fundamental construction of the heat pump. The energy in the bore hole (bedrock) or ground is drawn up by the cooling system. The compressor then increases the temperature to a usable level. Afterwards it releases the energy for the heating circuit and DHW.

Fresh water connections

Here you connect the property's fresh water connections. The cold water is directed down to the lower part of the coil.

Upper part

In the upper part of the coil the water is heated to the desired temperature.

DHW finned coil

EcoHeat is equipped with a well-dimensioned finned coil made of copper. A low temperature can be maintained without the risk of legionella bacteria.

Electric heater

A built-in electric heater acts as additional heat if the heat pump's output is not enough.

Lower part

In the lower part of the coil the DHW is pre-heated by the water heated by the heat pump. The larger section of the coil is located in this part.

Heat medium pump

The speed-controlled heat medium pump transports the cold water from the boiler to the condenser where the energy from the ground coil is drawn up and transferred to the heat pump.

Compressor

The compressor is the "heart" of the cooling system, pumping the refrigerant around in an airtight closed system. The evaporated refrigerant is compressed in the compressor. This enables the temperature to rise to a usable level. The energy is released to the boiler water in the condenser.

Expansion valve

The cooling system has a high pressure side (after the compressor) and a low pressure side (after the expansion valve). The expansion valve has the function of lowering the pressure on the refrigerant. This makes the temperature drop so that new energy can be drawn up into the evaporator. The expansion valve functions as a variable throttle valve depending on the current conditions in the cooling system.

Bivalent shunt valve

The automated mixing valve ensures that an even heat is continuously supplied to the heating circuit. The valve has four ports and first collects the radiator water from the lower part, heated by the heat pump.

Insulation

The heat pump's tank is insulated with cast polyurethane foam for minimal heat loss.

Flow conditioner

The heated water from the condenser heats up either the upper or lower part of the tank.

Condenser/Evaporator

In the condenser the refrigerant releases its energy into the heating system. The energy is used to heat the DHW and the house.

In the evaporator, heat drawn from the heat source (bedrock or ground) is released to the refrigerant, which is evaporated to be compressed later in the compressor.

Sound insulation

The cooling module is fitted with sound insulation since the compressor emits a certain amount of noise and vibrations.

Brine pump

The brine pump transports the freeze resistant water in the ground loop (cold side). The cold side constitutes a closed system.

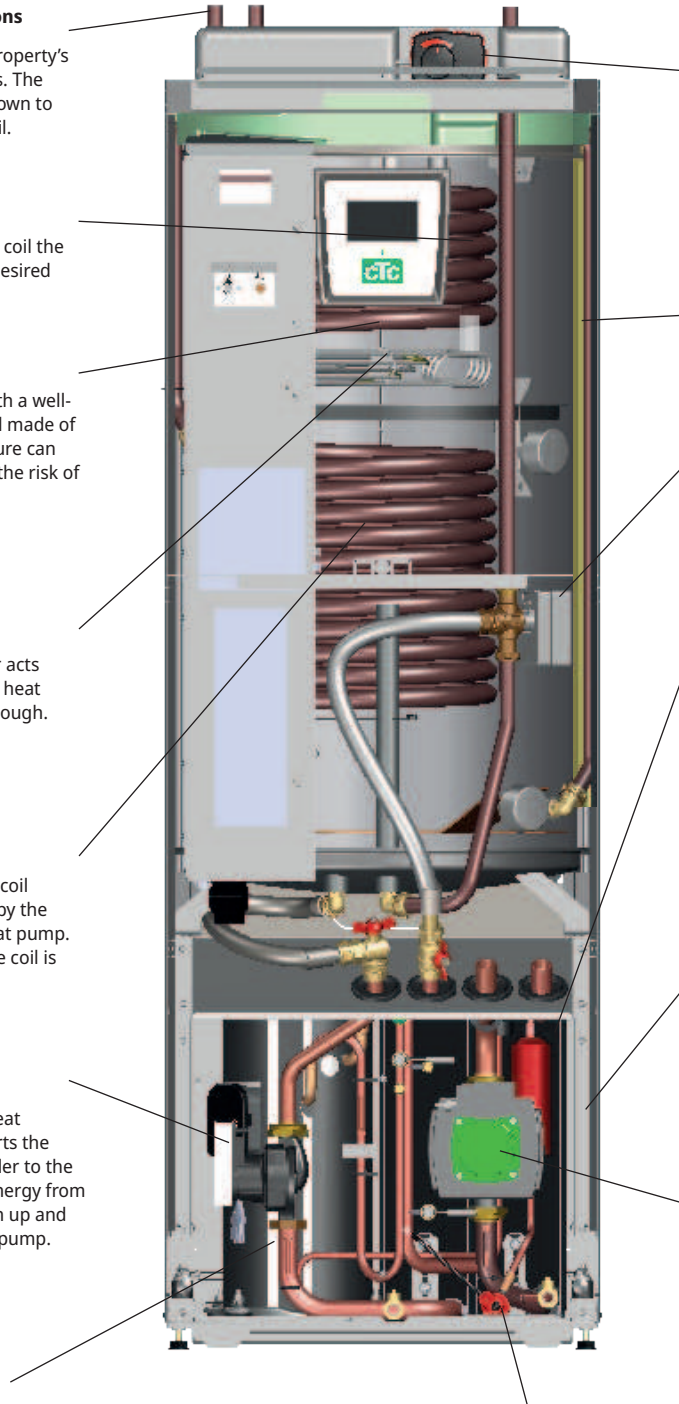

7. Parameter list EcoHeat 400

The tables show factory settings for important product parameters.

Heating circuit	Factory setting
Program Economy	-
Room temp change °C	-2.0
Off delay, min	No
SmartGrid Blocking	Off
Program Comfort	-
Room temp change °C	2.0
Off delay, min	No
SmartGrid Low price	Off
SmartGrid Overcapacity	Off
Program Custom	-
Room temp change °C	0.0
Off delay, min	No
SmartGrid Blocking	Off
SmartGrid Low price	Off
SmartGrid Overcapacity	Off
Max primary flow °C	55
Min primary flow °C	Off
Heating mode	Auto
Heating mode, ext.	-
Heating off, out °C	18
Heating off, time (min)	120
Night reduction down to °C	5
Room temp. reduced, Night red. °C (Prim flow.)	-2 -3
Room temp. reduced, Holiday °C (Prim flow)	-2 -3
Alarm room temp °C	5
SmartGrid Low price °C	Off
SmartGrid Overcapacity °C	Off
SmartGrid Blocking	Off
Anti Water Hammer	No
HP max DHW	No
Drying period mode	Off
Drying period temp °C	25

Heat pump	Factory setting
Compressor	Permitted
Brine pump	Auto
Compressor stop at brine °C	-5
Tariff HP	No
Tariff HP schedule	
SmartGrid block HP	No

Electric heater	Factory setting
Boiler upper add. °C	70
Boiler upper extra DHW °C	60
Boiler upper max kW	5.5
Delay mixing valve	180
Main fuse A	20
Conv. factor curr. sensors	1
Tariff EL	No
SmartGrid block immersion	No
SmartGrid block mixing valve	No

Upper tank	Factory setting
Program Economy	-
Stop temp HP °C	50
Boiler upper °C	40
Program Normal	-
Stop temp HP °C	60
Boiler upper °C	40
Program Comfort	-
Stop temp HP °C	60
Boiler upper °C	50
Start/stop diff. upper °C	7
Max time upper tank (min)	30
Max time lower tank (min)	20
Time lower after DHW (min)	10
SmartGrid Blocking °C	Off
SmartGrid Low price °C	Off
SmartGrid Overcapacity °C	Off
SmartGrid Overcapacity block HP	No
Time ExtraDHW Remote Control (min)	0.0

Lower tank	Factory setting
SmartGrid Low price °C	Off
SmartGrid Overcapacity °C	Off

Diff thermostat	Factory setting
Charge start diff temp °C	7
Charge stop diff temp °C	3
Charge temperature °C	60
Charge tank	No

Cooling	Factory setting
Room temp. cooling °C	25
SmartGrid Low price °C	Off
SmartGrid Overcapacity °C	Off
Ext. block cooling	No

8. Control system

CTC EcoHeat 400 has an advanced yet straightforward control system with a touchscreen on which all settings are entered directly.

The CTC EcoHeat 400 control system:

- monitors all functions in the system tank, heat pump and heating system.
- allows for individual settings;
- Displays desired values, such as temperatures, operation times, energy consumption and fault signals.
- Allows for simple and structured value setting and troubleshooting.

Factory values

CTC EcoHeat 400 is delivered with set factory values which are suitable for a normal house with a normal heating circuit. CTC EcoHeat 400 automatically adjusts the water temperature to the primary flow's current heating requirement. This is monitored by the control system, which continuously ensures that you are provided with optimum function and economy. These values are easy to change as and when required. Ask your installer to help you determine the correct values.

Heat pump

On delivery the compressor is blocked and must be enabled. This is done in the "Installer/Settings/Heat Pump" menu.

CTC EcoVent



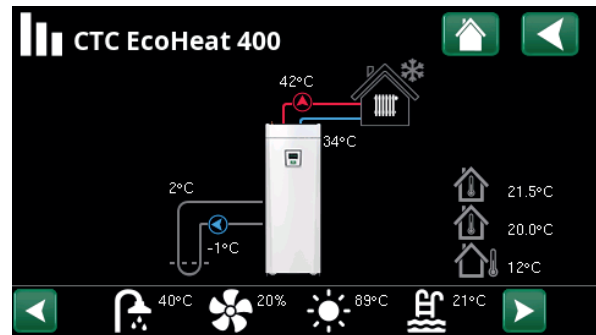
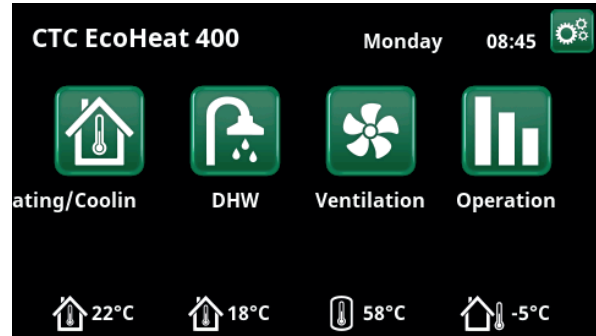



The product is ready for connection with the CTC EcoVent ventilation product.



The picture shows an example of operation data.

8.1 Quick start touchscreen

The illustration below shows the most common functions you need to set and use as the end customer.

	Scroll & Swipe	 Start menu	 increase value
	Single click = Select	 Back	 Select and save
	Double click = Open	 decrease value	 increase value



Start menu

Room temperature Heating Circuit 1
Measured by Room Sensor 1

Room temperature Heating Circuit 2
Measured by Room Sensor 2

Tank temperature
Measured by DHW Sensor in upper tank.

Outdoor temperature
Measured by Outdoor Sensor.

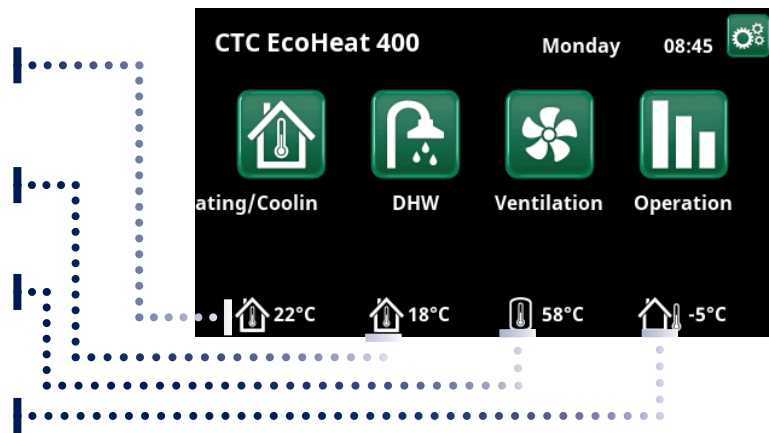

Heating/Cooling

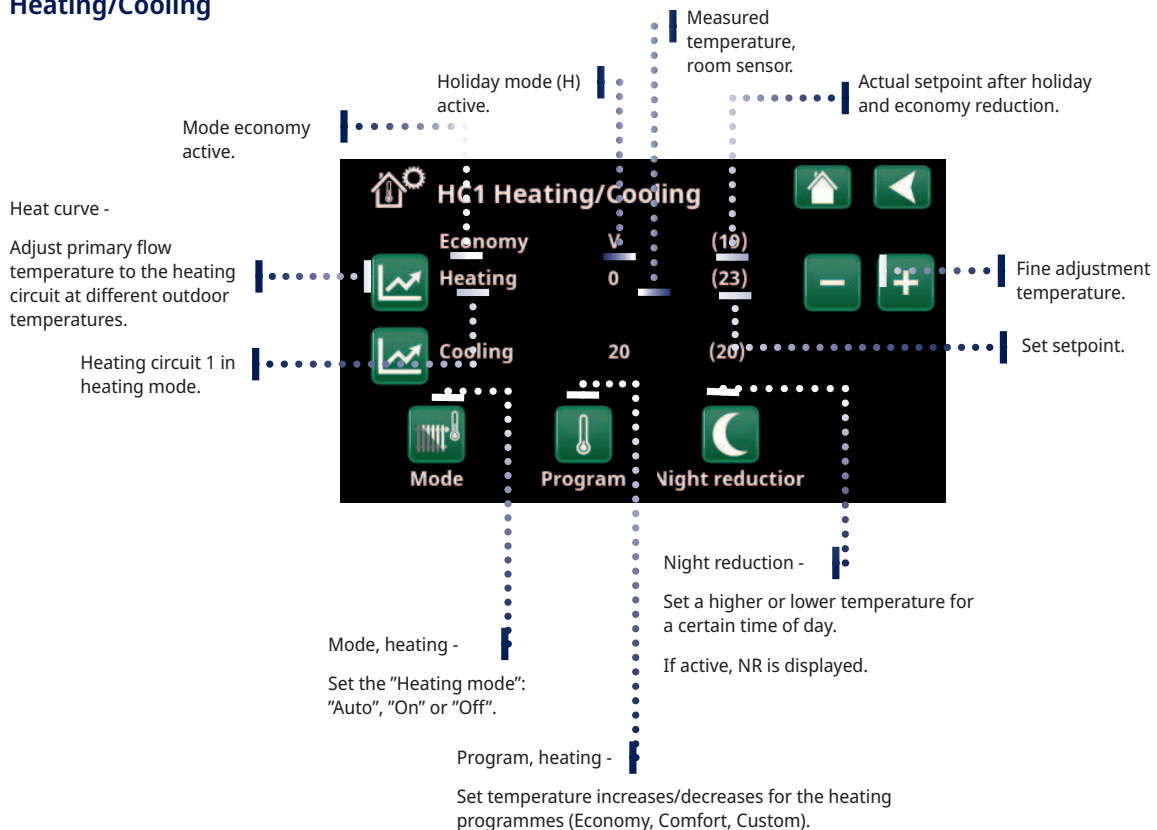



DHW

Schedule "Extra DHW"

Tip: Set the time approx. 1 hour earlier than when you need the hot water as it may take some time to heat.

Start Extra DHW Timer

Select DHW program

- Economy – Small DHW requirement
- Normal – Normal DHW requirement
- Comfort – Large DHW requirement

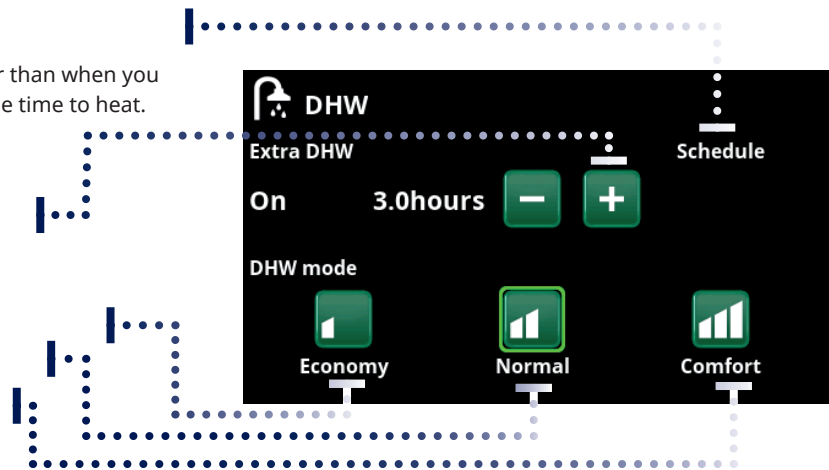

Ventilation

Refer to the manual for the EcoVent accessory.
The symbol is only displayed on the home screen if EcoVent is defined.



Operating information

Heating circuit

Control and tank

Functions

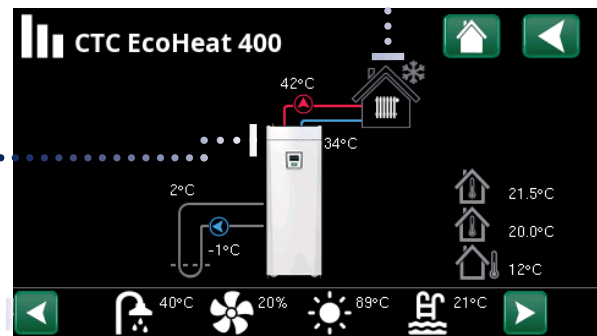

Main menu page for operation data of the defined system.

Click the images for detailed operation data about the respective part

For detailed operation data, a gear symbol is shown alongside the icon in the top left. The icon is a shortcut to settings for the respective part.

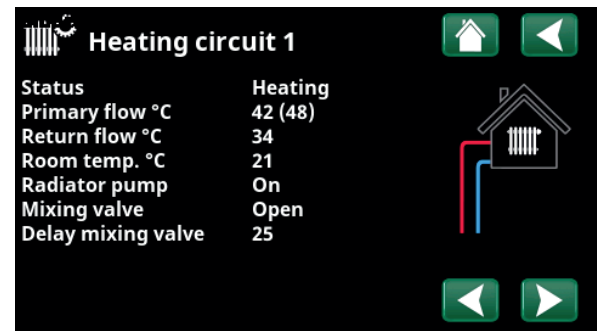

The menu shows detailed operation data of the selected heating circuit. Click the arrows or swipe to view defined heating circuits.



Shortcut to the "Installer/Settings/Heating Circuit 1" menu.



Installer

Settings and service, refer to detailed descriptions in the next chapter.

8.2 Installation wizard

When starting up the system and during reinstallation (refer to the "Installer /Service" chapter), a number of system options must be selected. The dialogue boxes which will then be displayed are described below. The values shown in the menu screenshots below are only examples.

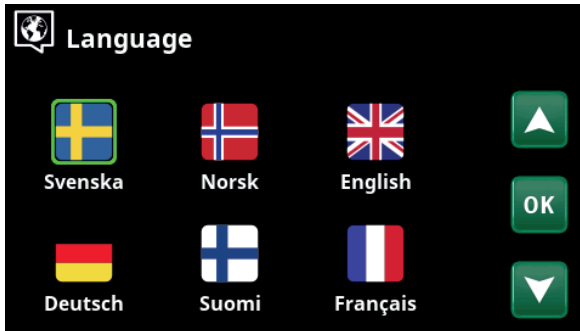

1. Choose language. Press OK to confirm.



2. Select the country where the heat pump is installed. Press OK to confirm.

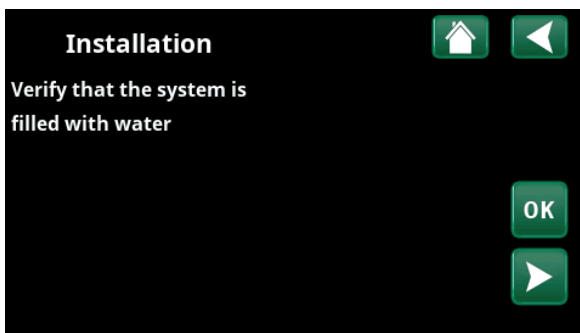

3. Verify that the system is filled with water. Confirm with "OK" and the "right" directional arrow.

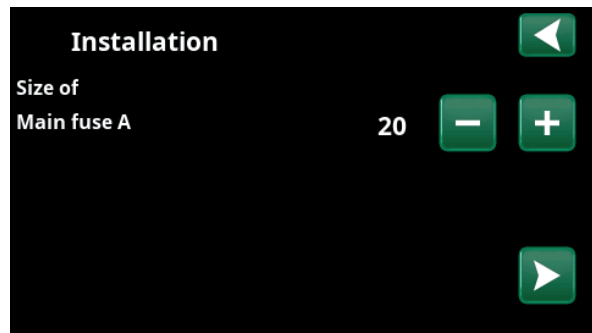

4. Select the size of the main fuse using the "+" and "-" buttons. Confirm with the "right" directional arrow. For more information about settings, refer to the "Installer/Settings/Electric Heater" chapter.

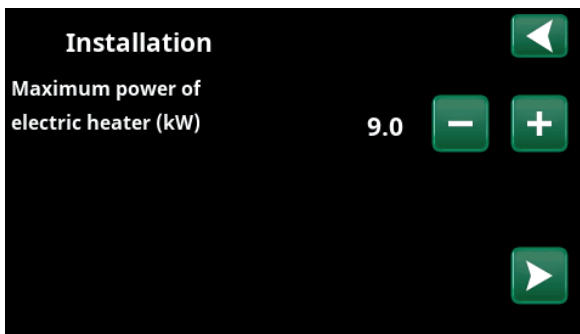

5. Select maximum electric heater power using the "+" and "-" buttons. Confirm with the "right" directional arrow. For more information about settings, refer to the "Installer/Settings/Electric Heater" chapter.

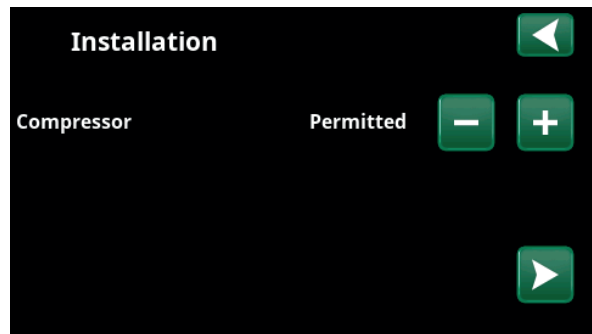

6. Specify whether the compressor is "Permitted" or "Blocked" using the "+" and "-" buttons. Confirm with the "right" directional arrow.

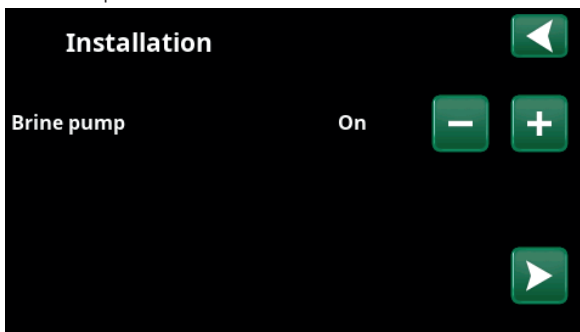

7. Specify whether the brine pump is "On", "10d" or "Auto" using the "+" and "-" buttons. Confirm with the "right" directional arrow. For more information about settings, refer to the "Installer/Settings/Heat Pump" chapter.

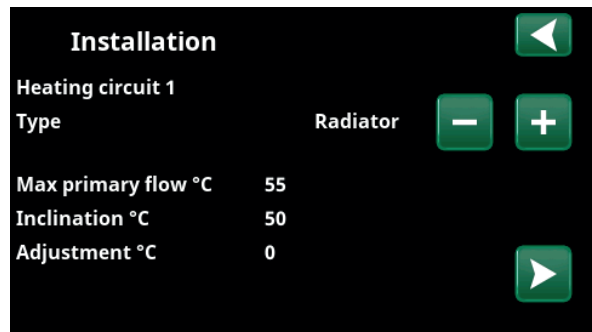

8. Specify whether heating circuit 1 applies to radiators or underfloor heating. Switch between "Radiator" and "Underfloor Heating" using the "+" and "-" buttons. Confirm with the "right" directional arrow.

9. If Heating circuit 2 is defined, the corresponding menu for this system is displayed. Make a corresponding selection ("Radiator" and "Underfloor Heating") for Heating circuit 2 and finish the wizard with "OK".

9. Detailed menu descriptions

All settings can be configured directly on-screen using the easy-to-read control panel. Operational and temperature information is also displayed here. You can easily enter the different menus to find information on the operation or to set your own values. For information about start-up and re-installation, refer to the "First Start" chapter at the back of this manual.

9.1 Start menu

This menu is the system's home screen. This provides an overview of the current operation data. The system returns to this menu if no buttons are pressed within 10 minutes. All other menus can be accessed from this menu. NB: Some menus are only shown if a heat pump is installed.

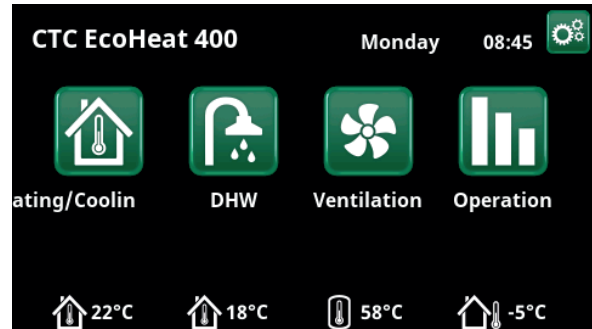

9.2 Alarm management

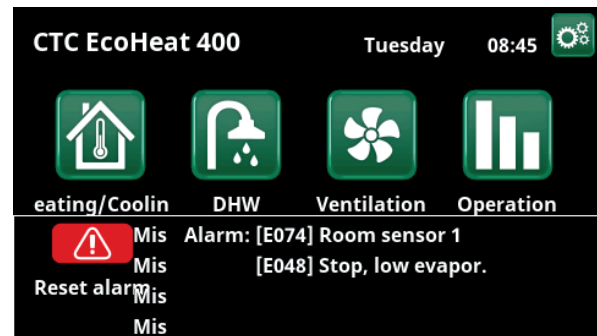
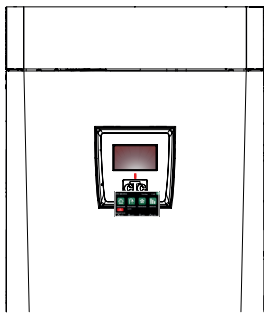

Signal	Status
Green LED	OK
Red/yellow flashing LED	Alarm
Green flashing LED	Operation with active electric heater - Applies only with language selection "Danish"
Info message at bottom	Information message about the current status



See troubleshooting chart at the very back of the installation manual.



Call your installation engineer in the first instance

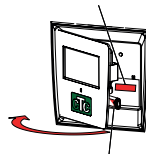

The serial number (12 digits) can be found behind the display. This number is needed to be given to the installation engineer and CTC support in the event of a fault report.



9.3 Heating/Cooling

In the menu "HC- Heating/Cooling" the following settings can be made:

9.3.1 Setpoint setting with room sensor

Set the desired room temperature (set point) with the "minus" and "plus" buttons. In the example in the "HC1 Heating/Cooling" menu, the "Economy" programme and "Holiday mode" (V) are active for heating circuit 1.

In the "HC2 Heating/Cooling" menu, the "Cooling" mode is active.

"Holiday mode" and "Night reduction" only lower the room temperature when heating mode is active.

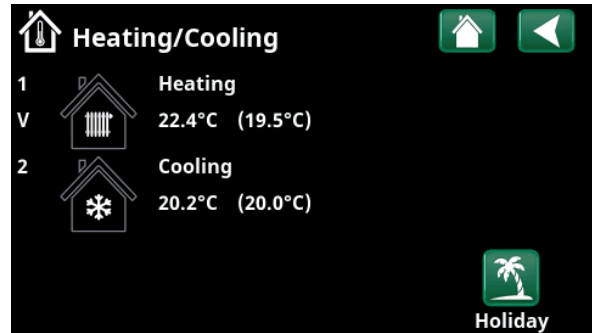

Click on heating circuit 1 or 2 to go to the menu of the respective heating circuit. In this menu you can activate "Holiday mode" for the heating circuits.

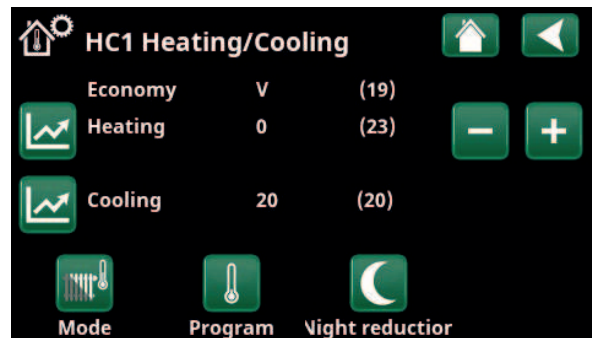

In the menu, programs "Economy" and "Holiday mode" (V) are active for heating circuit 1. In this example, both the "Economy" and "Holiday Mode" programmes are set to lower the set point (23.5 °C) by 2 °C, which means that the actual set point = $23.5 - 2 - 2 \text{ °C} = 19.5 \text{ °C}$.

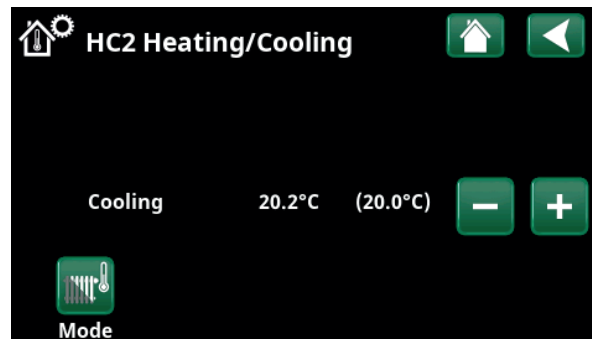

In the menu, "Cooling" (setpoint: 20.0 °C) is active for heating circuit 2. "Holiday mode" (V) does not lower the setpoint when cooling is active.



9.3.2 Program

Press the "Program" button and the heating program to be activated (Economy, Normal, Comfort or Custom). It is also possible to schedule the programmes.

See chapter "Installer/Settings/Heating circuit/Program" for information on how to set temperature increases/decreases and delay times for the programmes.



9.3.3 Heating curve

Press the heating curve symbol in the "HC1- Heating/Cooling" menu. The graph of the heating circuit heat curve is displayed.

The chapter "Installer/Installation/Heating circuit" describes the setting of the heating curve.

See also chapter "House heating curve" for more information on adjusting the heating curve.



9.3.4 Heating mode

Press the "Mode" button and then select "Heating mode"; "Auto", "On" or "Off".

Heating mode can also be selected in the menu "Installer/Settings/Heating circuit/Heating mode".

See chapter "Installer/Settings/Heating circuit" for more information.

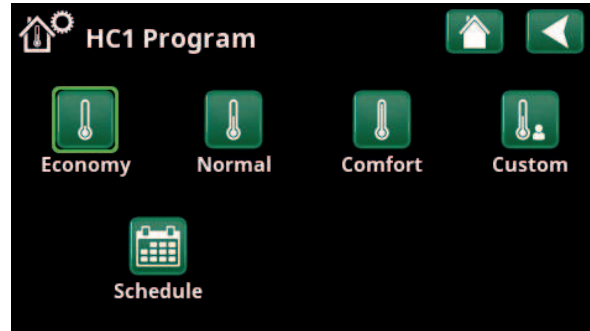

Menu "HC1 Heating/Cooling / HC1 Program" where program "Economy" has been activated.

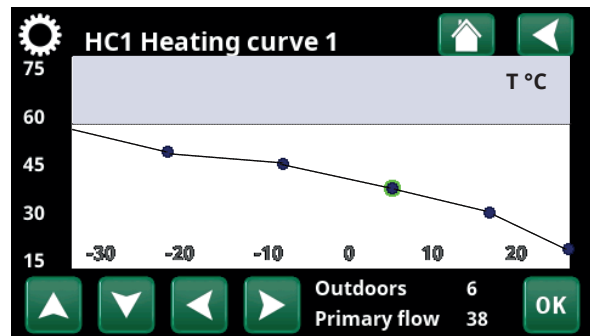

Menu "Heating/Cooling/HC1 Heating/Cooling".

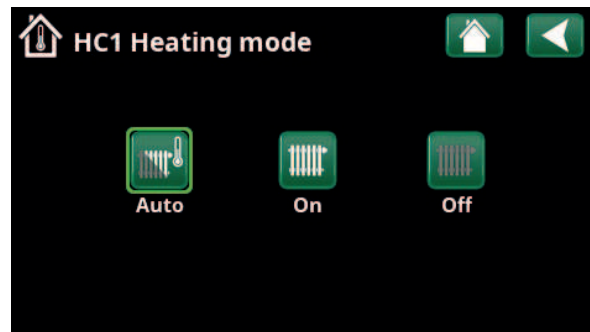

Menu "HC1 Heating/Cooling/HC1 Heating mode" where mode "Auto" has been activated.

9.3.5 Room temperature setting without room sensor

You can select "Room sensor - No" in the "Installer/Define/Heating circuit" menu. This is used if the room sensor is difficult to place, if the underfloor heating system control has its own room sensor or if you are using a wood-burning stove/fireplace. The alarm LED on the room sensor works as usual.

If a wood-burning stove or fireplace is used sporadically, the burning may cause the room sensor to reduce the temperature of the heating circuit and it may become cold in the rooms in other parts of the house. The room sensor can then be temporarily switched off during firing and the heat pump provides heat to the heating circuit according to the set heating curve. The radiator thermostats are throttled in the part of the house where the fire is burning.

If the room sensor has not been installed, the heating must be set according to the chapter "House heating setting".

9.3.6 Outdoor sensor/room sensor errors

If a fault occurs with an outdoor sensor, the product triggers an alarm and an outdoor temperature of -5 °C is simulated so that the house does not get cold.

If a fault occurs with a room sensor, the product triggers an alarm and automatically switches to operating according to the set curve.

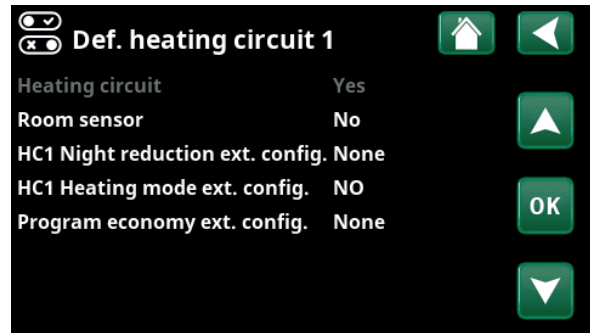

Menu "Installer/Define/Heating circuit/Heating circuit 1".

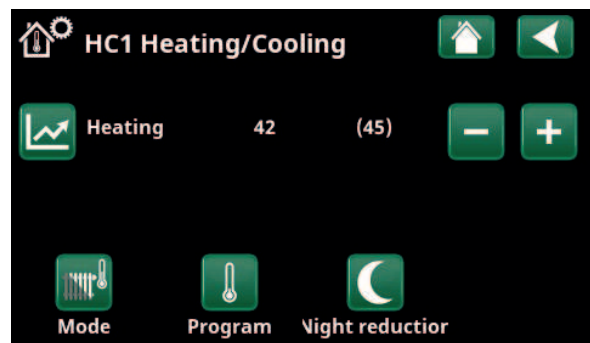

Menu "Installer/Define/Heating circuit/Heating circuit 1". The heating circuit has no room sensors. The setpoint (primary flow temperature 45 °C) is shown in brackets, the current primary flow temperature 42 °C is shown to the left of the setpoint.



9.3.7 Night Reduction Temperature

Night reduction means reducing the temperature indoors, via remote control or during scheduled periods.

In the menu "HC1 Night reduction" menu, the periods during the week for night temperature reduction can be scheduled.

The "Night reduction" icon in the "Heating/Cooling" menu only appears if a "Schedule" has been defined for the heating circuit in the "Installer/Define/Remote control" menu.

The "Schedule" chapter describes how to set schedules.

The value by which the temperature is reduced during remote control of the night reduction is set in one of the following menus.

Room sensor installed:

"Installer/Settings/Heating circuit/Room temp reduced night red °C".

Room sensor not installed:

"Installer/Settings/Heating circuit/Prim. flow reduced night red °C".

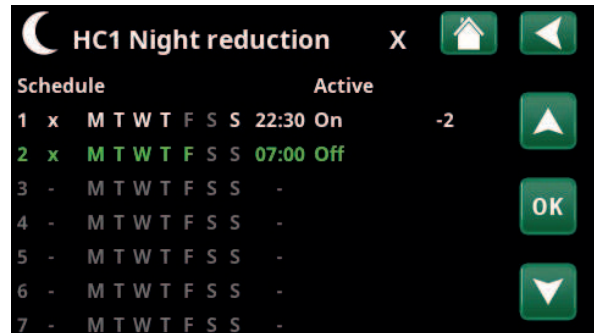

The schedule has been set for "Night Reduction" to be active weekdays between 22:30 and 07:00, except during the night between Friday and Saturday and the night between Saturday and Sunday (when no night reduction occurs).

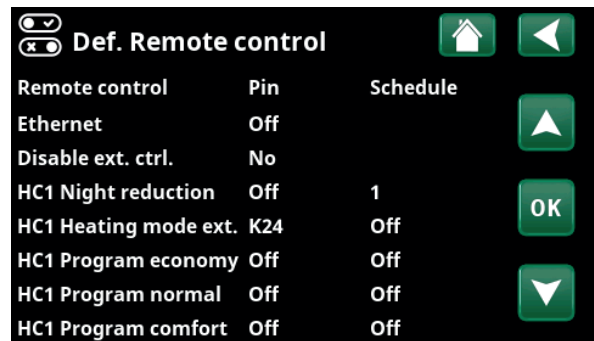

Menu: "Installer/Define/Remote Control".
The "HC1 Night Reduction" function is assigned to Schedule #1.



9.3.8 Holiday

This option is used to set the number of days that you want continuous reduction of inside temperature, for example if you want to go on holiday.

The value by which the temperature is reduced during the period is set in one of the following menus:.

Room sensor installed:

"Installer/Settings/Heating circuit/Room temp reduced holiday °C".

Room sensor not installed:

"Installer/Settings/Heating circuit/Prim. flow reduced holiday °C".

Holiday reduction is enabled from the time of setting (press the plus (+) sign).

Up to 300 days can be set.

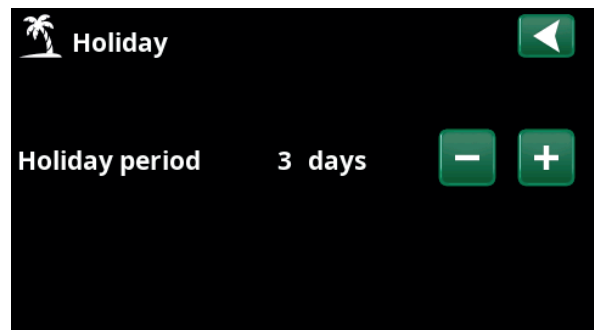

When holiday is enabled, hot water production is stopped. The "Temporary extra DHW" feature is also stopped.

When both "Night Reduction" and "Holiday Reduction" are in use, "Holiday Reduction" supersedes "Night Reduction".



9.4 DHW

This menu is used to set the hot water comfort level and "Extra DHW".

Extra DHW

The "Extra DHW" function can be activated here. When the function is activated (by setting the number of hours using the plus sign in the "Hot Water" menu), the heat pump immediately starts to produce extra DHW. It is also possible to remotely control or schedule hot water production according to specified times.

DHW mode

You set the values for this option which apply to the heat pump's normal operation. There are three modes:



Economy

For low hot water needs.
(Factory value stop temperature DHW tank: 50 °C).



Normal

Normal hot water needs.
(Factory value stop temperature DHW tank: 55 °C).



Comfort

For high hot water needs.
(Factory value stop temperature DHW tank: 58 °C).

9.4.1 Extra DHW

You can use this menu to schedule periods during weekdays when you want extra DHW. This schedule is repeated every week.

The stop temperature for Extra DHW is 60 °C (factory setting).

The "Schedule" chapter describes how to set schedules.

Click the "Extra DHW" heading to obtain a graphical overview of when the schedule is active during weekdays.

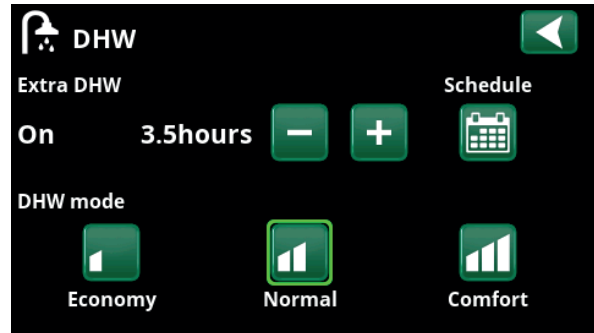

The "Extra DHW" function is set to be active for 3.5 hours.

NB: Set the time approx. 1 hour earlier than when you need the hot water as it may take some time to heat-up.

Tip: Set to "Economy" mode from the start. If the hot water is deemed insufficient, raise to "Normal" mode, and so on.

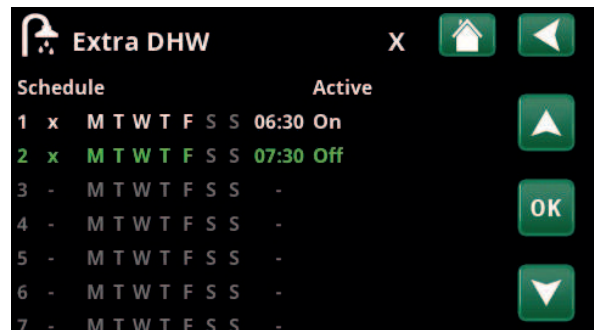

The "Extra DHW" function is set to be active on weekdays between 06:30 and 07:30.

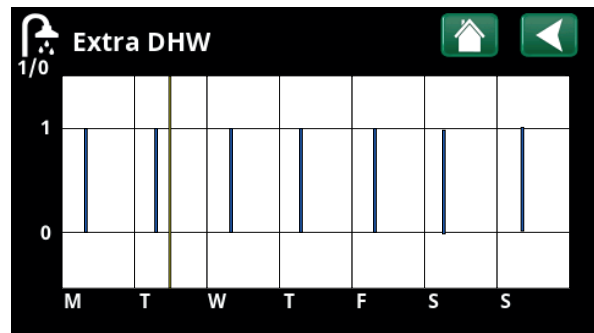

Use the Back button to switch between settings and preview. A vertical blue bar indicates when "Extra DHW" is active. A horizontal yellow line indicates the current time. The X axis represents the days, Monday to Sunday.



9.5 Ventilation

Refer to the "Installation and Maintenance Manual" for the CTC EcoVent ventilation product.

9.6 Schedule

In a Schedule, the periods can be set for when a function should be active or inactive during the weekdays.

The system does not allow certain functions to be active at the same time on the same schedule; for example, the "Night Reduction" and "Extra DHW" functions, but most functions can share the same schedule.

If several functions share the same schedule, changes to the schedule for one function will cause the same changes for the other functions that share the schedule.

To the right of the schedule header, an "X" will appear if the same schedule is also shared by another remote control function.

Click on the schedule's header row to see a graphical overview of when the schedule is active during the days of the week.

9.6.1 Defining a schedule

In this example, a night temperature reduction of heating circuit 1 (HC1) is programmed.

First, a schedule must be defined in the "Installer/Define/Remote control" menu.

Enter a schedule (1-20) in the "Schedule" column in the "HC1 Night Reduction" row using the arrow keys, or click where the cursor is in the example.

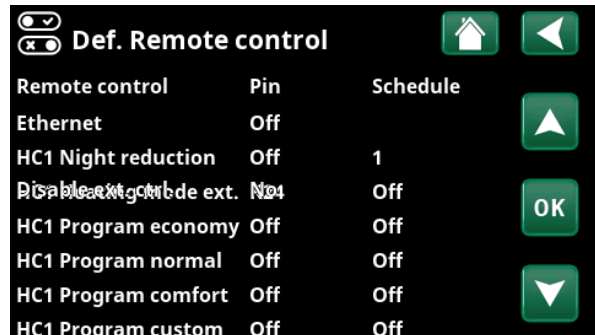

Menu: "Installer / Define/Remote Control".

The "HC1 Night Reduction" function is assigned to Schedule #1.

9.6.2 Schedule settings

A schedule can be set for most remotely controlled functions in the menus under "Installer/Settings".

However, schedules for "Night reduction", "Extra DHW" and "Ventilation" can only be accessed via the start menu.

The schedule includes 30 rows and a setting can be made in each row. For example, in one row you can set the date and time for the function to activate, and the time the function should deactivate in the row below.

In the example, "Night reduction" for heating circuit 1 has been set to be "On" from 22:30 to 07:00 on weekdays, except for weekends (Friday and Saturday nights).

The second row is highlighted green, which means that row is active at the current time.

Schedule **Active**
(Active/Inactive/Restore factory settings)

Activate the schedule by setting it to "Active" mode. It is also possible to restore factory settings.



Click on the "Night Reduction" icon in the heating circuit "Heating/Cooling" menu to set the schedule.

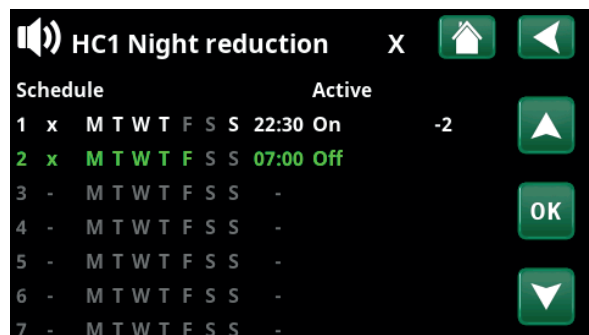

The schedule has been set for "Night Reduction" to be active weekdays between 22:30 and 07:00, except during the night between Friday and Saturday and the night between Saturday and Sunday (when no night reduction occurs).

9.6.3 Editing a schedule

Go down to the first row and press "OK" to enable editing mode.

Time

Use the arrow keys to change the time (hours and minutes, respectively).

Day by day

Use the arrow keys (up arrow /down arrow) to mark active days in bold.

Action Off (On/Off)

This normally indicates whether the row will switch the function "On" or "Off".

However, for the "Night Reduction" and "SmartGrid Schedule" functions, the following applies:

- In the schedule for "Night Reduction", the temperature reduction that will apply during the period is specified in °C here instead. When a temperature is specified (setting range -1 to -30 °C), the status of the row automatically switches to "On".
- When setting a "SmartGrid schedule", the SmartGrid function (SG Block., SG Low price and SG Overcapacity) is specified in the "Action" row. The status of the row automatically switches to "On".

Active Yes (Yes/No)

"Yes" means that the row is activated.

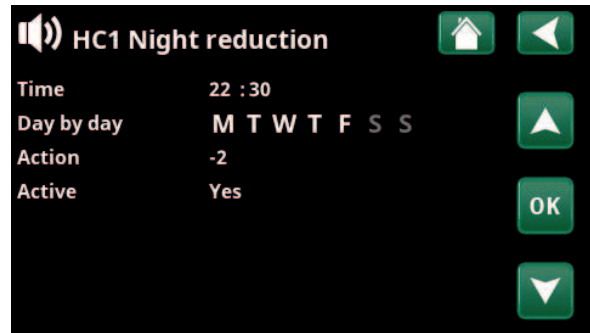

Setting the Night Reduction (-2 °C), weekday nights.



The SmartGrid function "SG Low Price" is scheduled for weekdays 22:30-06:00. Go to the menu by selecting "SmartGrid schedule" in the "Installer/Settings" menu.



9.7 Operation data

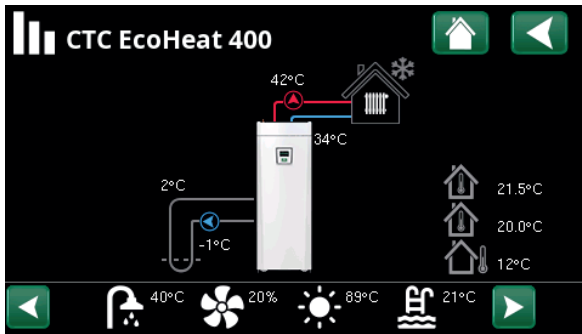

i NB: The operation values shown in the menu screenshots are only examples.

Main menu page for "Operation Data".
When the pumps are in operation, the pump icons also rotate on screen.



Outside Temperature

Measured temperature, outdoor sensor.



Indoor temperature.

Shows the room temperature for defined heating circuits (room sensors 1 and 2).



Brine temperature

Current temperature (2 °C) of the brine from the collector in the heat pump and return temperature (-1 °C) of the brine back into the collector hose.



Heating circuit

Current primary flow temperature (42 °C) to the house is shown to the left in the menu. Current return temperature (34 °C) is shown below.

The icon bar at the bottom of the menu page displays icons for additional functions or subsystems that have been defined.

Scroll using the arrows or swipe in the list if not all the icons fit on the page.

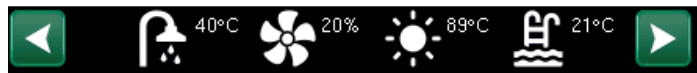

Ventilation



Pool



Solar Panel



Diff thermostat



DHW



History



EcoTank/
X volume



El.prices

The gear icon is a shortcut to "Settings" for the respective part.





9.7.1 Operation data, Control unit

Status HP upper

Current charging mode, see table below.

Tank upper °C 49 (60)

Temperature and setpoint in the upper part of the tank.

Tank lower °C 42 (50)

Temperature and setpoint in the lower part of the tank.

Electric power kW 0.0 + 2.5

Electric boiler's additional power. Lower and upper electric heaters. Example of 0.0 kW in lower electric heater and 2.5 kW in upper electric heater.

Current L1/L2/L3 A 8.6 / 9.1 / 8.9

Total current consumption of the house at the various phases L1/L2/L3, provided that three current sensors have been fitted to incoming cables in the house. If the current sensors mounting devices are not identified, only the phase with the highest load is displayed.

If the current exceeds the main fuse size, the boiler automatically switches down a power step to protect the fuses, for example, when several high-consumption appliances are being used in the house.

Three values are displayed for "Current" when the current transformers are connected and identified. If only one digit is displayed:

- connect all three current transformers.
- then select in the "Installer/Service/Check current sensors" menu.

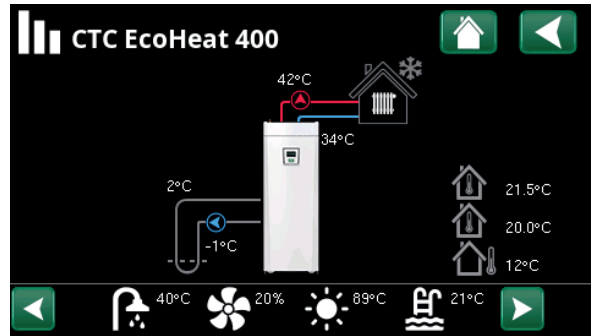

Main menu page for operation data of the defined system.

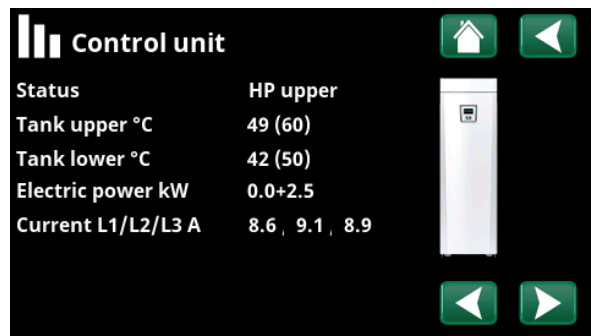

Menu: "Operation Data/Control Unit". Click the arrows or swipe to switch between the Control Unit and Heat Pump.

i The first figure indicates the current operational value, and the value in brackets indicates the setpoint which the heat pump is trying to achieve.

Control unit status	
HP upper	The heat pump heats the upper part of the tank (DHW production).
HP lower	The heat pump heats the lower part of the tank. (Heat production).
HP+Add. Heat	Both the electric heater and heat pump heat the tank.
Additional heat	Only the electric heater heats the tank.



9.7.1 Operation data, Heating circuit*

Mode Custom

Shows the active DHW program.

Status Heating

Shows the operational status of the heating circuit. See the table below.

Primary flow °C 42 (48)

Temperature and setpoint (in brackets) supplied to heating circuit.

Return flow °C 34

Temperature returned to heating circuit.

Room temp. °C 21 (22) (25)

Shows the room temperature for the heating circuit if room sensor installed. In brackets, the setpoint is shown for the "Heating" and "Cooling" status.

Radiator pump Off

Radiator pump mode (On/Off)

Mixing valve Open <50%

Shows whether the mixing valve increases (opens) or decreases (closes) the heating flow to heating system 2 and when the mixing valve is in the "<50%" or ">=50%" position.

Delay mixing valve 25

A microswitch in the mixing valve's motor ensures that auxiliary heating is not used unnecessarily, for example, when ventilating a room or if the temperature (outdoors) occasionally drops during the night. The mixing valve is delayed for the time period selected before auxiliary heating is used. The screen shows the countdown of the delay in minutes. If "Blocked" is shown, never open the mixing valve towards the upper tank electric heater.

SmartGrid Off

Shows the status of the SmartGrid functions for the selected heating circuit.

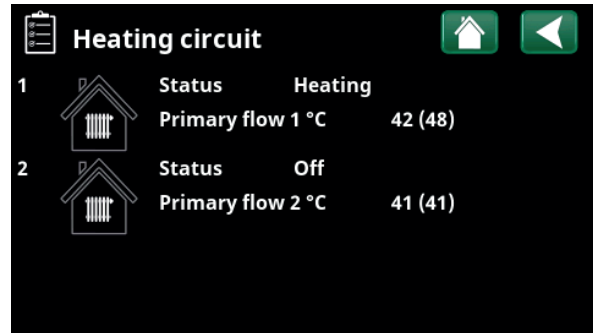

"Operation data, heating circuit" menu. The menu shows the current temperatures and status of defined heating circuits.

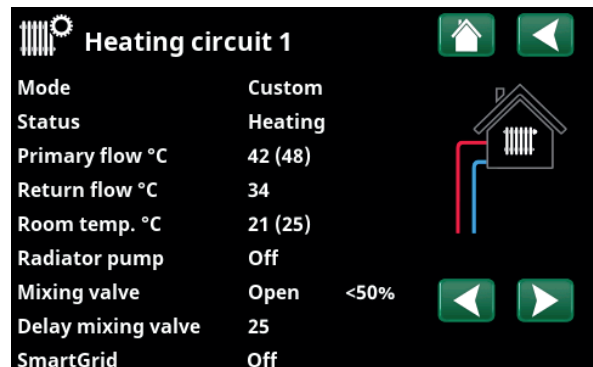

The menu shows detailed operation data of the selected heating circuit. Click the arrows or swipe sideways to view defined heating circuits.

*The heat pump can control up to 2 heating circuits.

Heating circuit status	
Heating	Heat is produced for the heating circuit.
Cooling	Cooling is produced for the system.
Holiday	Room temperature Holiday reduction active.
Night reduction	Room temperature Night reduction active.
Off	No heating/cooling produced.



9.7.1 Operation Heat Pump (HP)

Status **On, heating**

Heat pump status, see table

Compressor **On**

Shows whether the compressor is operating or not (On/Off).

Charge pump **On 50%**

Shows operating status of the charge pump ("On" or "Off") and the flow in percent (0-100).

Brine pump **Off**

Shows operating status of the brine pump ("On" or "Off") and the speed in percent.

Brine in/out °C **-2.0 / 1.0**

Shows the heat pump's return and primary flow brine temperatures.

HP in/out °C **48.0 / 53.0**

Shows the heat pump's incoming and outgoing temperatures.

Current A **4.4**

Shows the current across the compressor.

Software HP PCB **20220518**

Shows the heat pump software version.

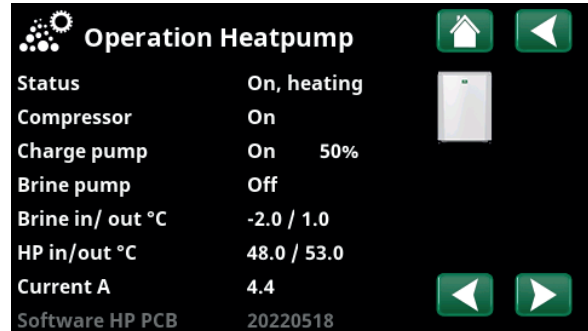

The menu shows the status and operating temperatures of defined heat pumps. Click the arrows or swipe to switch between the "Control Unit" and "Heat Pump".

Heat pump status	
On	The heat pump is in the "On" position.
On, DHW	The heat pump heats the DHW tank.
On, cooling	The heat pump is producing cooling for the heating circuit
On, heating	The heat pump is producing heat for the heating circuit.
Start delay: 1 min.	Compressor off - prevented from starting due to 1 min. start delay.
Off	Heat pump not charging the tank - no need.
Blocked in menu	Compressor Blocked in the "Installer/Settings/Heat Pump" menu.
Communication error HP	Control unit not communicating with heat pump.
Off, start ready	Compressor off but ready to start.
Off, alarm	Compressor off - alarm activated.
Stop, tariff	Compressor blocked due to active remote control function.
Blocked, low brine in °C	Incoming brine temperature too low, compressor blocked.
Flow on	Flow in the charging coil.



9.7.4 Stored Operation data

This menu shows cumulative operation values.

The operation values shown in the menu screenshots are only examples. The historical operational info presented varies depending on the language choice.

Total operation time h 3500

Shows the total time the product has been powered.

Max primary flow °C 51

Shows the highest temperature that has been supplied to the heating circuit.

Energy el. total (kWh) 250

Shows how much additional heat has been used.

Compressor

Operation time /24 h:m 07:26

Shows total operating time during the last 24 hours.

Total operation time 1500

Displays total compressor operating time in hours.

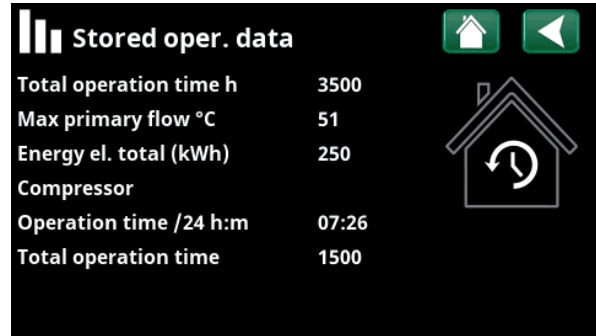

Menu: "Stored oper. data".



9.7.5 Operation data, DHW

Mode Normal

Shows the active DHW program (Economy/Normal/Comfort).

Tank upper °C 49 (60)

Temperature and setpoint in the upper part of the tank.

Extra DHW On

"On" means the "Extra DHW" function is active.

SmartGrid SG Low price

If SmartGrid is defined, the current status is displayed. This affects DHW production.



"Operation Data/DHW" menu.



9.7.6 Operation data, Diff thermostat function

Status On

Differential thermostat function Shows whether charge pump (G46) is switched on (On/Off).

Temperature °C 51

External tank temperature at which charging starts. Measured by sensor B46.

Target temp. °C 43

External tank temperature at which charging stops.

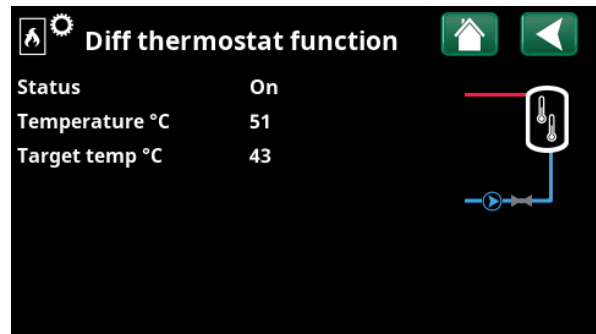

Menu: "Operation Data/Diff. thermostat function".



9.7.7 Operation data, El.prices

This menu is displayed if "El.prices" has been defined in the "Installer/Define/Communication" menu.

El.price mode **High**

Indicates the current price category ("High", "Medium" or "Low").

El.price/kWh **SEK 7.5**

Indicates the current electricity price in local currency.

Display the "Preview data" graph by clicking the "Graph icon" at the bottom-left of the menu screen.

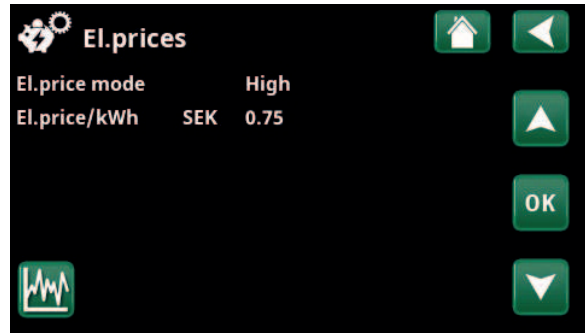

Menu: "Operation/El.prices".

For more information and examples of Smart Electricity Price Control/SmartGrid, see the website www.ctc-heating.com/Products/Download.



9.7.8 External signal

The menu shows the functions that are active via external control. The functions can be activated with:

- myUplink
- Virtuell digital in
- Modbus
- Relay
- SmartControl sensors

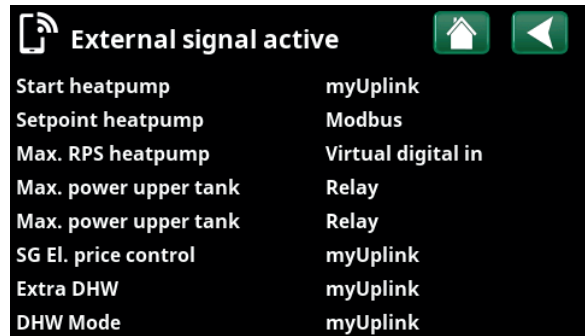

Menu: "Operation/External signal active".



Installer

This menu contains four sub-menus:

- Display
- Settings
- Define
- Service



For "System Information", click the "i" button in the lower right corner of the screen in the "Installer" menu. This displays the product serial number, MAC address, and application and bootloader versions. Click "Legal Information" to view information regarding third-party licences.

Scan the QR code with a tablet or smartphone. When your phone/tablet is connected to your local network, the product can be used with your device's touchscreen in the same way as the product's screen.

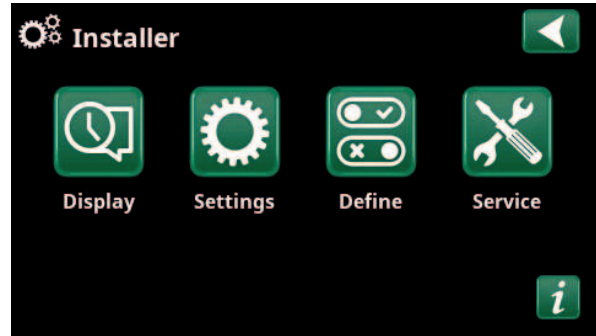

Menu: "Installer".

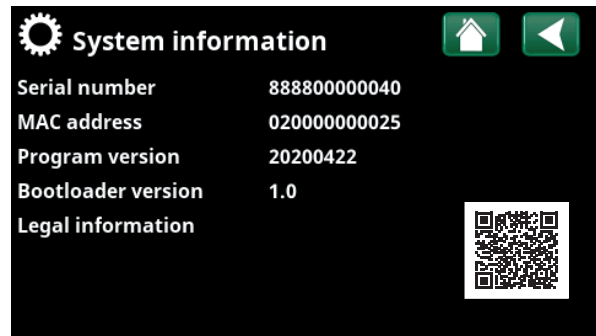

Menu: "Installer/System information". To access this menu, click the "i" button in the lower right corner of the "Installer" menu.



4.2 Display

Time, language and other screen settings can be carried out from this menu.



4.2.1 Setting the time

Time and Date

Click on the time symbol. The menu can also be accessed by clicking the date or time in the upper right corner of the start screen.

Press "OK" to highlight the first value and use the arrows to set the time and date.

DST (On, Active)

The left value can be set. "On" means the time is adjusted according to Summer Time.

The right value is fixed and shows the current status (for example, "Off" during the winter period). The display does not need to be connected to power for the values to be adjusted, since this occurs at the next start-up.

SNTP

Menu option "On" retrieves the current time from the internet (if online). More settings options can be found in the "Installer/Settings/Communication/Internet" menu.

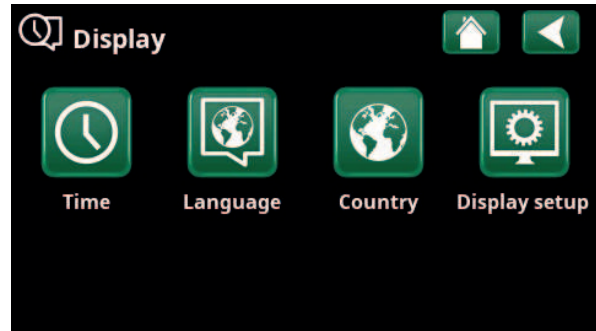

Menu: "Installer/Display".

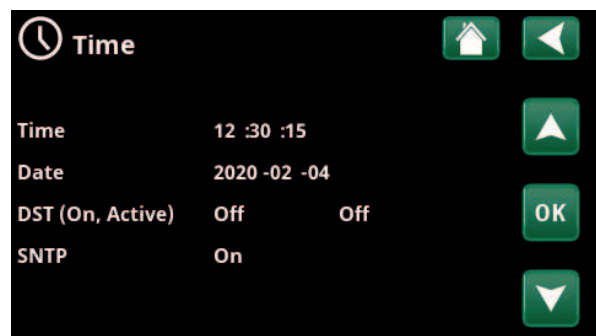

Menu: "Installer/Display/Time".



4.2.2 Language

Click a flag to select the language. The language selected is highlighted with a green square. To view more language options than those shown in the menu, scroll down the page, or press the down arrow key.



4.2.3 Country

Click on the "Country" symbol in the "Installer/Display" menu to display selectable countries and regions. The country that is displayed (highlighted in green) depends on which language has been selected.

"English" is the default language setting, which means that "GB United Kingdom of Great Britain and Northern Ireland" is the default country setting.

Select the country where the plant is installed to get correct spot prices. Depending on which country is selected, product-specific factory settings may vary.

"Country" must also be selected to receive correct electricity prices when controlling electricity prices via the myUplink mobile app.



4.2.4 Display setup

Sleep delay 120 (Off, 1...360)

Enter the time in minutes before the display enters sleep mode if not touched. Settings can be applied in 10 min. intervals.

Backlight 80% (10...90)

Set the brightness of the backlit display.

Click sound Yes (Yes/No)

Enable or disable button sounds.

Alarm sound Yes (Yes/No)

Enable or disable alarm sounds.

Time zone, GMT +/- +1 (-12...14)

Set your time zone (relative to GMT).

Lock code 0000

Press "OK" and use the arrows to set a 4-digit lock code. If a lock code is set, it is shown as four stars. You will be prompted to enter the code when the screen is restarted.

NB: Make a note of the lock code for your own reference when you enter it in the menu for the first time.

The serial number of the display (12 digits) can also be entered to unlock the display (enter '0000' + serial number); see chapter "Installer/System Information".

The display can be locked by clicking the product name in the upper left of the start menu, whereupon you will be prompted to enter the lock code.

A lock code can be deleted by entering "0000" in this menu instead of the previously specified lock code.

Font size Standard (Small/Standard/Large)

The display's font size can be changed here.

Selection colour 0 (0/1/2)

Option to change the cursor background colour for clearer selection according to the light conditions.

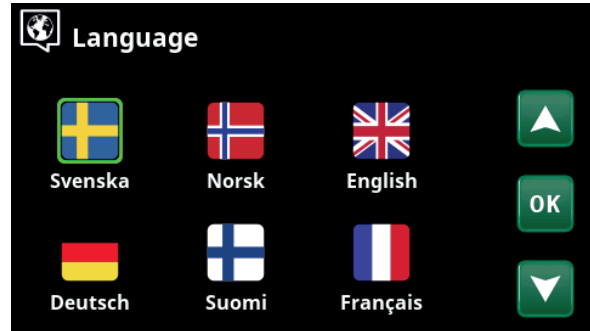

Menu: "Installer/Display/Language".



Menu: "Installer/Display/Country".

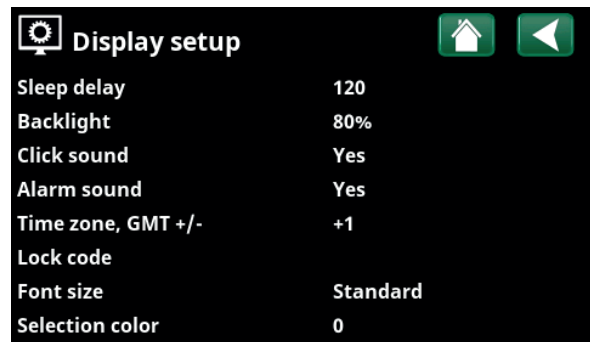

Menu: "Installer/Display/Display Setup".



9.9 Settings

This is used to set the parameters for your home's heating requirements. It is important that this basic setting is right for your home. Values which are set incorrectly may mean that your property is not warm enough or that an unnecessarily large amount of energy is being used to heat your property.

i First define the desired functions, see "Installer/Define". Settings are only displayed for enabled functions.

9.9.1 Settings Heating circuit*

In the "Settings" menu, select "Heating circuit" and then the heating circuit to be set.

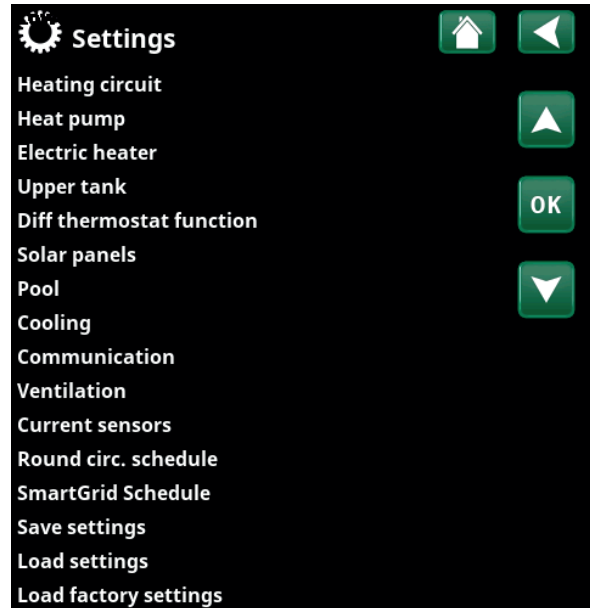

Menu: "Installer/Settings".

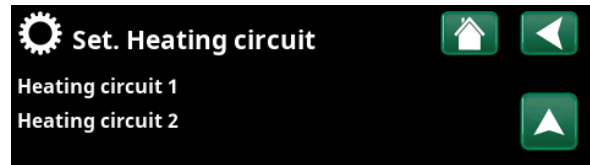

Part of the "Installer/Settings/Heating Circuit" menu.

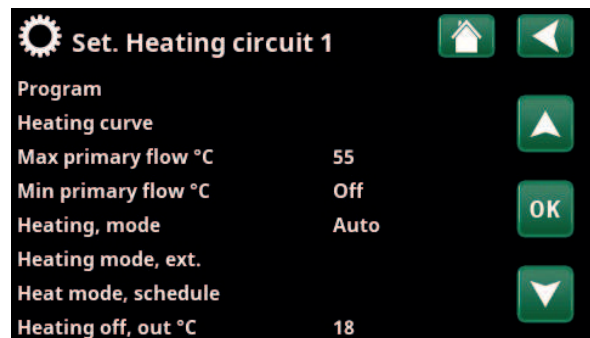

Part of the "Installer/Settings/Heating Circuit/Heating Circuit 1" menu.

*The heat pump can control up to 2 heating circuits.

Program

Press "OK" on the "Program" menu bar to make settings for the "Economy", "Comfort" and "Custom" heating programs. Selected programme is marked with an "X".

To activate a heating program or set a schedule, press the "Program" button from the "Heating/Cooling" menu. See chapter "Control system / heating/cooling".

• Primary flow change °C **-5 (-20...-1)**

The menu bar is displayed if the room sensor is not defined for the heating circuit. Setting "-5" (factory value program "Economy") means that the setpoint of the primary flow is lowered by 5 °C when the program is active.

• Room temp change °C **-2.0 (-5.0...-0.1)**

The menu bar is displayed if the room sensor is defined for the heating circuit. Setting "-2" (factory value program "Economy") means that the set setpoint for room temperature is lowered by 2 °C when the program is active.

• Off delay, min **No (No/10...600)**

Off delay means the time in minutes after the heating program "Economy", "Comfort" or "Custom" has been activated as the heating mode returns to the program "Normal". However, if the "Custom" program is selected later than the "Normal" program, the "Custom" program will apply after the Off delay. The Off delay is adjusted in steps of 10 minutes for each key press (up or down arrow).

"No" means that the selected program will be activated until another heating program is activated.

• SmartGrid Blocking* **Off (Off/On)**

The menu bar is displayed when setting the heating programme "Economy" or "Custom".

"On" means that the heating program is activated when "SmartGrid Blocking" is active.

SmartGrid Low price* **Off (Off/On)**

The menu bar is displayed when setting the heating programme "Comfort" or "Custom".

"On" means that the room temperature is increased according to the setting for "SmartGrid Low price °C" when "SmartGrid Low price" is active.

SmartGrid Overcapacity* **Off (Off/On)**

The menu bar is displayed when setting the heating programme "Comfort" or "Custom".

"On" means that the room temperature is increased according to the setting for "SmartGrid Overcapacity °C" when "SmartGrid Overcapacity" is active.

• Reset program

Current program is reset with factory values.

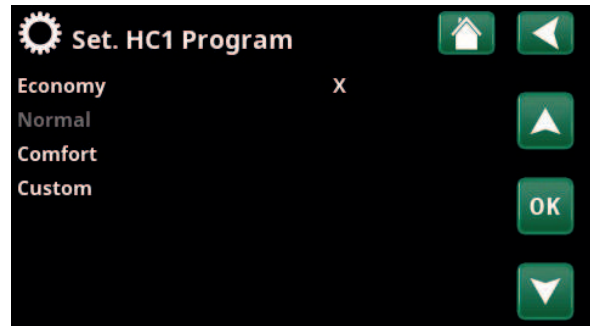

Menu "Installer/Settings/Heating Circuit/Heating Circuit 1/Program".

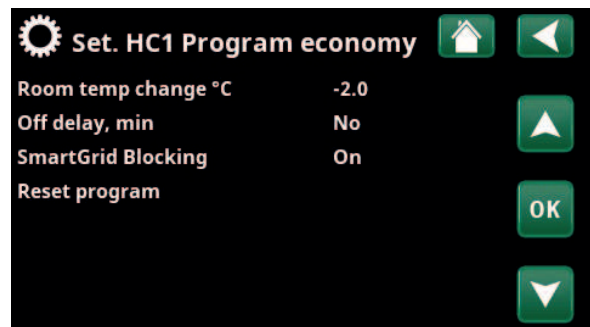

Menu "Installer/Settings/Heating Circuit/Heating Circuit 1/Program/Economy".

*SmartGrid functions are set in the menu "Installer/Settings/Heating circuit".

Heating curve

The heating curve determines the primary flow temperature (and thus the indoor temperature) to the heating circuit at different outdoor temperatures.

See chapter "House heating curve" for more information on adjusting the heating curve.

Possible choices are "Set. heating curve", "Fine adjustment", "Active curve", "Copy from ..." and "Reset curve".

• Set. heating curve

The thicker line shows the factory-set curve while the thinner line shows the active heating curve to be reset. Here it is possible to adjust the appearance of the graph by adjusting the curve inclination and curve adjustment with the buttons below the graph. The adjustments you make here affect the entire appearance of the graph, while the changes made under "Fine adjustment" are made one point at a time. Curve inclination is adjusted with the left and right arrows while curve adjustment is adjusted with the up and down arrows. Confirm with "OK".

• Fine adjustment

The graph of the active heating curve for the heating circuit is displayed. The heating curve can be adjusted in 5 points on the graph. Touch a point (becomes green) to change its position in the x-axis (outdoor temperature) and y-axis (primary flow temperature). Use the up/down/left/right buttons below the graph or press and drag the point.

Below the graph, the outdoor and primary flow temperatures for the selected point are shown. The heating curve can also be adjusted from the "Heating/Cooling" menu. See chapter "Control system / heating/cooling".

• Active curve 1 (1/2)

This menu bar shows the selected heating curve, it is possible to choose between two different heating curves per heating circuit.

• Copy from 1 (2)

The function "Copy from ..." is useful if you have created two different heating curve graphs but want to restore one graph to the same appearance as the other and then make changes.

Example: If heating curve 1 is selected as "Active curve", heating curve 1 will have the same appearance as heating curve 2 by selecting the line "Copy from 2" and pressing "OK". The menu bar cannot be selected (marked with gray) when heating curves 1 and 2 have the same values (the graphs look the same).

• Reset curve

Resets the active heating curve to the factory-set curve.

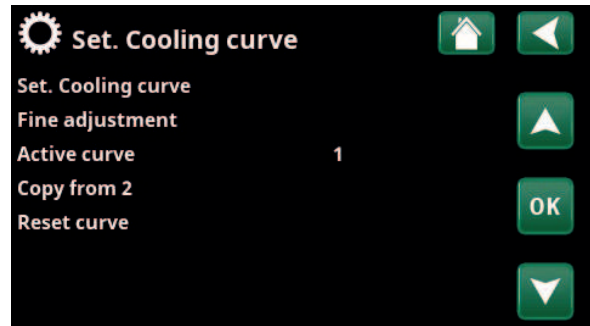

Menu "Installer/Settings/Heating Circuit/Heating Circuit 1/Heating curve".

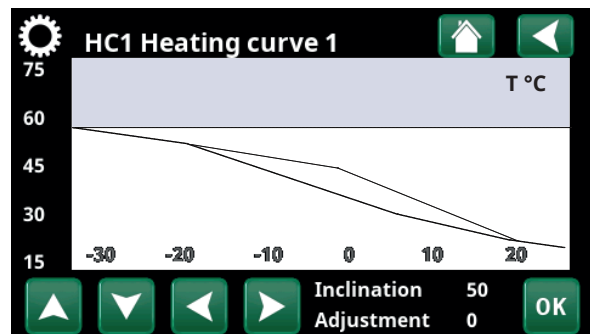

Menu "Installer/Settings/Heating Circuit/Heating Circuit 1/Heating curve".

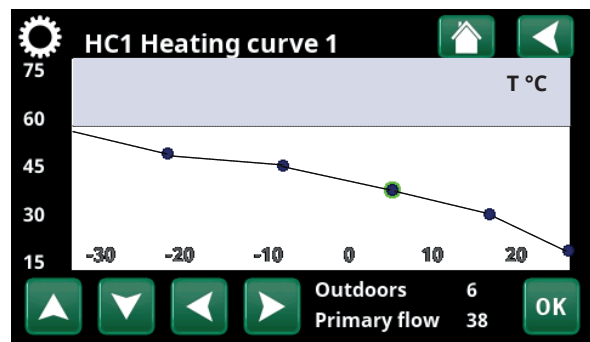

Menu "Installer/Settings/Heating Circuit/Heating Circuit 1/Heating curve/Fine adjustment".

Max primary flow °C 60 (30...70)

Maximum permitted temperature supplied to the respective heating circuit.

Min primary flow °C Off (Off/15...65)

Minimum permitted temperature supplied to the respective heating circuit.

Heating, mode Auto (Auto/On/Off)

Switching between heating season and summer mode can take place automatically (Auto) or a selection can be made here to set the heating to "On" or "Off".

Heating mode can also be selected from the start page by pressing the "Mode" button in the Heating/Cooling menu.

- **Auto** = switching the heating season On and Off carried out automatically.
- **On** = Continuous heating season, the radiator pump circulates constantly.
- **Off** = there is no heating, the radiator pump does not run (is turned over).

Heating mode, ext. - (Auto/On/Off)

The heat mode selected in this menu can be enabled/disabled externally.

This menu bar is displayed for the current heating circuit if a remote control input or a schedule has been defined for the function.

Read more in the "Def. Remote Control" section of the "Installer/Define" chapter.

Heat mode, schedule

This menu bar is displayed if a schedule has been defined for the "HC Heat Mode, ext." function in the remote control menu.

For more information, refer to:

- chapter "Schedule".
- section "Def. Remote Control" of the "Installer/Define" chapter for defining the remote control function.

Heating off, out °C 18 (2...30)

Heating off, time (min) 120 (30...1440)

Heating on, time (min) 120 (30...1440)

The menu bars can only be set if the "Auto" mode is selected in the "Heat Mode" menu above. Otherwise, the menu bars are locked (greyed out).

When the outdoor temperature exceeds (or equals) the set value in the "Heating off, out °C" menu during the time (in minutes) set in the "Heating off, time (min)" menu, the production of heat for the house is stopped.

This means the radiator pump stops, and the mixing valve remains closed. The radiator pump is activated daily for a short period to prevent it from jamming. The system restarts automatically when heating is needed.

When the outdoor temperature drops to the limit where heating is needed again, heat to the house is permitted when the temperature falls below (or equals) the set value in the "Heating off, out °C" menu for the number of minutes set in the "Heating on, time (min)" menu.



Innst. Varmesystem 1	
Program	
Varmekurve	
Maks turlledning °C	55
Min turlledning °C	Av
Varmemodus	Auto
Varmemodus, ekst.	
Varme skjema	
Varme av, ute °C	18
Varme fra, tid (min)	120
Varme til, tid (min)	120
Nattsenking ned til °C	5
Romtemp senkes nattsenking °C-2	
Romtemp senkes ferie °C	-2
Turl. senkes nattsenking °C	-3
Turlledning senkes Ferie °C	-3
Alarm lav romstemp. °C	5
SmartGrid Lavpris °C	Av
SmartGrid Overkap. °C	Av
SmartGrid Blokkering	Av
Nøyaktig tur	Nei
VV heving	Nei
Gulvfunksjon	Av
Gulvfunksjon temp °C	25
Gulvfunksjon modus	Av

Menu "Installer/Settings/Heating Circuit/Heating Circuit 1".

Night reduction down to °C **5 (-40...40)**

When the outdoor temperature is lower than this, the "Night Reduction" function stops since too much energy is consumed and it takes too long to increase the temperature again.

This menu overrides remote control of "Night Reduction".

Room temp. reduced, Night red °C **-2 (0...-30)**

Room temp. reduced, Holiday °C **-2 (0...-30)**

The menus are displayed if room sensors are installed for the heating circuit. The number of degrees by which the room temperature should be lowered during remote-controlled night reduction and during holidays can be set here. Night reduction can also be set periodically; the temperature decrease is then entered in the schedule.

Prim. flow reduced, Night red °C **-3 (0...-30)**

Prim. flow reduced, Holiday °C **-3 (0...-30)**

The menus are displayed if room sensors are not installed for the heating circuit. The number of degrees by which the primary flow temperature for the heating circuit should be lowered during remote-controlled night reduction and during holidays can be set here. Night reduction can also be set periodically; the temperature decrease is then entered in the schedule.

Alarm room temp °C **5 (-40...40)**

If the room temperature is too low (according to the set value), the message "Alarm, low room temp." will be displayed.

This menu bar is displayed if the room sensor is connected and defined.

SmartGrid Low Price °C **1 (Off/1...5)**

Setting to increase the room temperature at "Low price" energy price, via SmartGrid.

Both SmartGrid A and SmartGrid B must be defined in the remote control menu for this menu to be displayed.

Read more in the "Remote Control/SmartGrid A/B" section of the "Installer/Define" chapter.

SmartGrid Overcapacity °C **2 (Off/1...5)**

Setting to increase the room temperature at "Overcapacity" energy price, via SmartGrid. This function is not used for electricity price control.

Both SmartGrid A and SmartGrid B must be defined with a remote control input for this menu to be displayed.

Read more in the "Remote Control/SmartGrid A/B" section of the "Installer /Define" chapter.

SmartGrid Blocking **Off (Off/On)**

"On" means the heating circuit is blocked at "High" energy price, via SmartGrid. If the outdoor temperature falls below the value set in the "Night reduction down to °C" menu, this function is not activated.

Both SmartGrid A and SmartGrid B must be defined with a remote control input for this menu to be displayed.

Read more in the "Remote Control/SmartGrid A/B" section of the "Installer /Define" chapter.

● If room sensors are installed, the "Room temp reduced..." menu is displayed. If there are no room sensors, the "Primary flow reduced..." menu is displayed.

Example

As a rule, a "Primary flow reduced" reduced value of 3 to 4 °C is equivalent to a reduction of approximately 1 °C in room temperature in a normal system.

Anti Water Hammer

No (No/Yes)

Anti Water Hammer means that the heat pump never switches over and heats the upper tank (DHW charging). This is provided solely by the electric heater. In summer mode however, i.e. if the outdoor temperature is above the limit (Heating off, outdoor), the heat pump will be allowed to send water to the upper tank.

HP max DHW

No (Yes/No)

When the Anti Water Hammer has been selected, the "DHW increase" function opens.

- "Yes" means that the heat pump will follow the temperature of the radiators for 3 start-ups. When the heat pump performs start-up no. 4 the heat pump works until it achieves "maximum heat pump temperature".
- "No" means that the heat pump will always follow the temperature need of the radiators.

Drying period mode

Off (Off/1/2/3)

Applies to Heating circuit 1. Drying period for newly built properties. The function limits the calculation of primary flow temperature (setpoint) for "Your home's heating settings" to the schedule below.

Mode 1 - Drying period for 8 days

1. The setpoint of the radiator system is set to 25 °C for 4 days.
 2. On Days 5-8, the set value in "Drying period temperature °C" is used.
- (From Day 9 onwards the value is calculated automatically according to "Your home's heating settings")

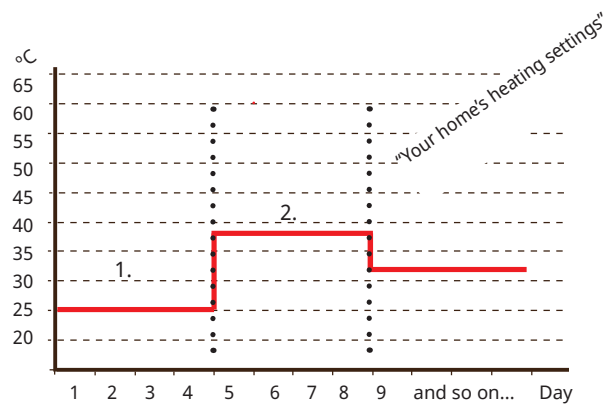

Example: Mode 1 with set value "Drying period temp °C": 38.

Mode 2 - Drying period for 10 days + stepped increased and decrease

1. Stepped increase start: The setpoint of the radiator system is set to 25 °C. The setpoint is then raised by 5 °C each day until it is equal to the "Drying period temp °C". The final step may be less than 5 °C.
2. Drying period for 10 days.
3. Stepped decrease: After the stepped increase and 10 days at an even temperature, the temperature setpoint is reduced to 25 °C in daily 5 °C stages. The final step may be less than 5 °C.

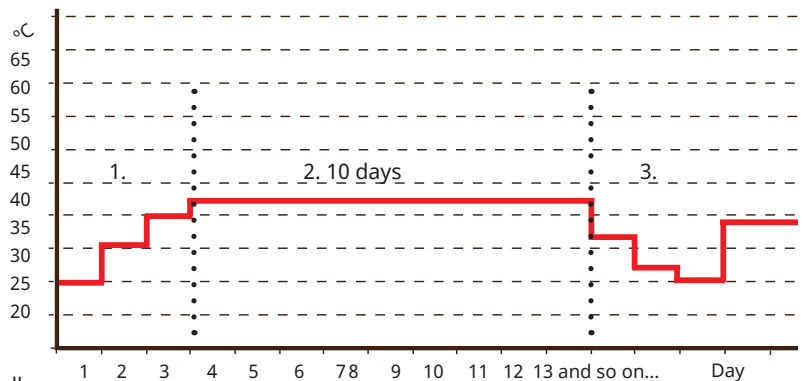

Example: Mode 2 with set value for "Drying period temp °C": 37.

(Following the stepped decrease and 1 day at the setpoint of 25 °C, the value is calculated automatically according to "Your home's heating settings").

Mode 3

In this mode, the function starts in "Mode 1" followed by "Mode 2" and lastly by "Your home's heating settings".

Drying period temp °C

25 (25...55)

The temperature for "Mode 1/2/3" as shown above is set here.

Drying period mode

Off (Off/On)

This menu bar is displayed for Heating Circuit 2 if a heating mode (1-3) is selected in the "Drying period mode" menu above.

The "On" option means that the drying period mode selected for Heating Circuit 1 will also be run for the selected heating circuit.

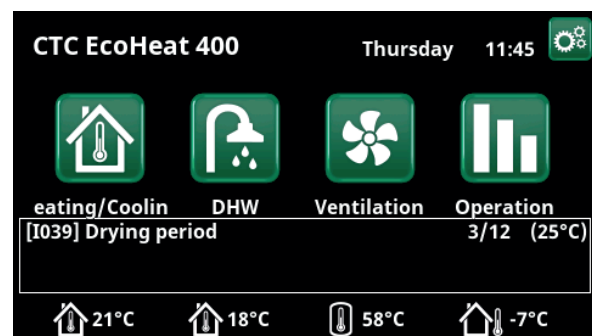

Example: Drying period temperature day 1 of 12 with current set point of 25 °C.

9.9.2 Settings Heat pump

Compressor **Permitted (Permitted/Blocked)**

The heat pump is supplied with a blocked compressor. "Permitted" means that the compressor can start.

Brine pump **Auto (Auto/10 days/On)**

After installation is complete, you can choose to run the brine pump constantly for 10 days to remove air from the system. The brine pump then enters "Auto" mode. "On" means the brine pump runs constantly.

Compressor stop at brine °C **-5 (-7...10)**

This menu defines the brine temperature at which the compressor will be stopped.

Tariff HP **No (No/Yes)**

"Yes" means the function can be activated via remote control.

Read more in the "Def. Remote Control" section of the "Installer/Define" chapter.

Tariff HP schedule

This menu bar is displayed if a schedule has been defined for the "HP Tariff" function.

For more information, refer to:

- chapter "Schedule".
- section "Def. Remote Control" of the "Installer/Define" chapter for defining the remote control function.

SmartGrid block HP **No (No/Yes)**

"Yes" means that the heat pump is blocked when "SmartGrid Blocking" is active.

Read more in the "Remote Control/SmartGrid" section of the "Installer/Define" chapter.

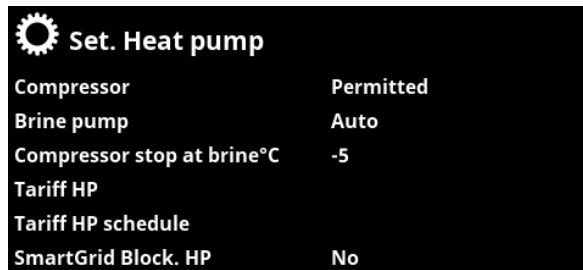

Set. Heat pump	
Compressor	Permitted
Brine pump	Auto
Compressor stop at brine °C	-5
Tariff HP	
Tariff HP schedule	
SmartGrid Block. HP	No

Menu: "Installer/Settings/Heat pump".

9.9.3 Settings Electric heater

Boiler upper add. °C 70 (30...70)

Temperature when the electric heater kicks in and helps EcoHeat 400 to produce DHW when there is great demand. The electric heater is also responsible for providing the house with additional heating. If the house requires a higher temperature than that selected, the control system compensates by automatically raising the temperature of the electric heaters.

This temperature also reflects the settings chosen under DHW.

Boiler upper extraDHW °C 60 (30...70)

This means the boiler is to provide extra DHW. This setting determines whether the electric heater should help to produce extra DHW. Set the temperature of the electric unit to the desired value when the option for extra DHW is activated under the DHW menu. A lower value means the heat pump produces the majority of DHW.

Boiler upper max kW 5.5 (0...9.0)

Setting for the maximum permitted power for the electric unit. 0 to 9.0 kW in steps of 0.3 kW.

The setting range varies, see "Electrical data" in the chapter "Technical data". For "Country" Germany and France, the max electric power is factory set at 0.0 kW.

Delay mixing valve 180 (30...240, Blocked)

The mixing valve delay, the period before it draws energy from the electric heater, is set here. Adjustable 30 to 240 minutes. If the value is set to "Blocked", the mixing valve will never open to the boiler.

Main fuse A 20 (10...35)

The property's main fuse size is set here. This setting and the fitted current sensors ensure the fuses are protected when using appliances which generate temporary power peaks, for example, cookers, ovens, engine heaters, etc. The product temporarily reduces power drawn where this type of equipment is being used.

Conv. factor curr. sensors 1 (1...10)

This menu contains the factor the current sensor is to use. This setting is only performed if the connection has been installed for a current sensor for higher currents.

Tariff EL No (Yes/No)

This menu bar is displayed if an "Input" for remote control is defined for the "Tariff EL" function in the "Installer/Define/Remote Control" menu.

"Yes" means the function can be activated via remote control.

Read more in the "Installer/Define/Remote Control/Tariff EL" chapter.

Tariff EL schedule

This menu bar is displayed if a "Schedule" is defined for the "Tariff EL" function in the "Installer/Define/Remote Control" menu.

For more information, refer to:

- chapter "Schedule".

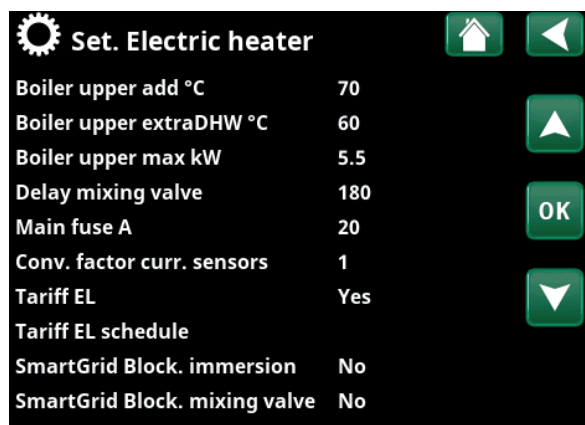

Menu: "Installer/Settings/Electric heater".

- section "Def. Remote Control" of the "Installer/Define" chapter for defining the remote control function.

SmartGrid Block. immersion No (Yes/No)

For this menu to be displayed, define a remote control input for both SmartGrid A and SmartGrid B.

"Yes" means that the additional heat is blocked when "SmartGrid Blocking" is active.

Read more in the "Installer/Define/Remote Control" chapter.

SmartGrid Block. mixing valve No (Yes/No)

The menu bar is displayed if the "SmartGrid block immersion" selection on the row above is "Yes".

When blocked, the mixing valve for the heating circuit does not open more than 50% if the need arises.

"Yes" means the function can be activated via remote control.

9.9.4 Settings Upper tank

DHW program

Available options are "Economy", "Normal" and "Comfort".

Press "OK" to open the settings for the selected DHW program. The factory settings shown below apply to "Normal" mode. Refer to the "Parameter List" chapter for the "Economy" and "Comfort" modes' factory settings.

• **Stop temp HP °C** **60 (40...60)**

At the selected temperature, the heat pump stops charging the upper tank.

• **Boiler upper °C** **40 (30...60)**

Hot water charging starts when the temperature falls below the set temperature.

• Reset program

The current DHW program will be reset to factory settings.

Start/stop diff. upper °C **5 (3...10)**

Temperature diff. before the heat pump starts or stops charging the upper tank.

Max time upper tank (min) **30 (10...150)**

This is the maximum time in minutes spent by the heat pump charging the upper tank if required in the lower tank.

Max time lower tank (min) **20 (10...120)**

This is the maximum time in minutes spent by the heat pump charging the lower tank if required in the upper tank.

Time lower after DHW (min) **1 (0...15)**

This is the maximum time in minutes spent by the heat pump charging the lower tank after charging the upper tank if heating is needed and the tank temperature is below its maximum value.

SmartGrid Blocking °C **Off (Off/-1...-50)**

The setpoint for DHW tank heating is decreased by the value set in this menu when "SmartGrid Blocking" is active.

Both SmartGrid A and SmartGrid B must be defined in the remote control menu for this menu to be displayed.

Read more in the "Def. Remote Control /SmartGrid A/B" section of the "Installer/Define" chapter.

SmartGrid Low price °C **Off (Off/1...30)**

The setpoint for DHW tank heating is increased by the value set in this menu when "SmartGrid Low price" is active.

Both SmartGrid A and SmartGrid B must be defined in the remote control menu for this menu to be displayed.

Read more in the "Def. Remote Control /SmartGrid A/B" section of the "Installer/Define" chapter.

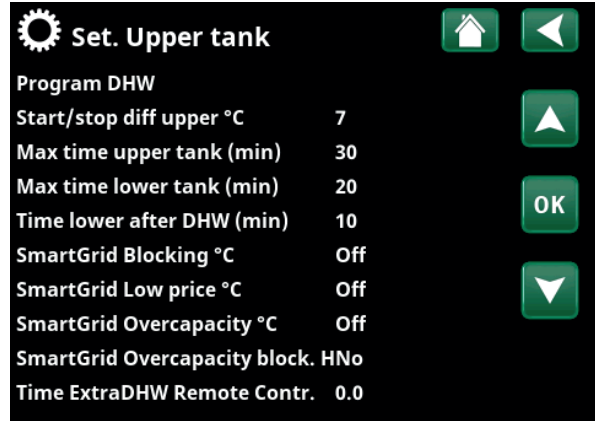

Menu: "Installer/Settings/Upper tank".

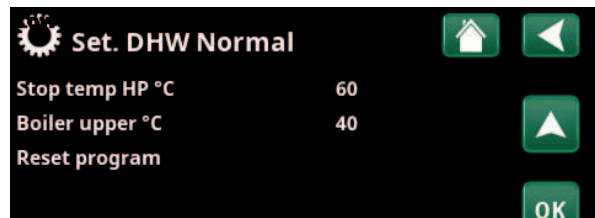

Menu: "Installer/Settings/Upper tank/DHW Program/DHW Program Normal".

SmartGrid Overcapacity °C **Off (Off/1...30)**

The setpoint for DHW tank heating is increased by the value set in this menu when "SmartGrid Overcapacity" is active.

Both SmartGrid A and SmartGrid B must be defined with a remote control input for this menu to be displayed.

Read more in the "Def. Remote Control /SmartGrid A/B" section of the "Installer/Define" chapter.

SmartGrid Overcapacity block HP **No (No/Yes)**

"Yes" means that DHW tank heating using the heat pump is blocked when "SmartGrid Overcapacity" is active.

Time ExtraDHW Remote Contr. **0.0 (0.0...10.0)**

Time in full or half hour intervals during which the "Extra DHW" function is enabled when activated in the Remote Control menu (Installer/Define system/Remote control/Extra DHW), or when activated by a CTC SmartControl accessory For CTC SmartControl functionality and settings, please refer to the relevant manual.

9.9.5 Settings Lower tank

SmartGrid Low price °C Off (Off/1...30)

The setpoint for lower tank heating is increased by the value set in this menu when "SmartGrid Low price" is active.

Both SmartGrid A and SmartGrid B must be defined in the remote control menu for this menu to be displayed.

SmartGrid Overcapacity °C Off (Off/1...30)

The setpoint for lower tank heating is increased by the value set in this menu when "SmartGrid Overcapacity" is active.

Both SmartGrid A and SmartGrid B must be defined with a remote control input for this menu to be displayed.

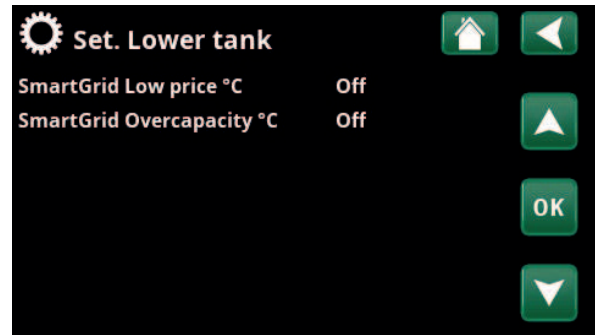

Menu: "Installer/Settings/Lower tank".

9.9.5 Settings Diff thermostat function

The function must be defined before the settings can be entered. Diff thermostat function is used to charge the system tank from a different heat source.

Charge start diff temp °C 7 (3...30)

Here you can set the temperature difference determining when charging from the heat source is started. The heat source must be this many degrees warmer than the tank temperature for charging to start.

Charge stop diff temp °C 3 (2...20)

The temperature difference which determines when charging from the heat source is stopped is set here. When the temperature difference between the product and the tank falls below this set value, charging stops.

Charge temperature °C 60 (10...80)

The maximum permitted temperature in the lower tank is set here. The charging stops if this temperature is exceeded.

Charge tank No (No/Yes)

Overcharging from the heat pump's lower tank to the buffer tank starts when:

- Setting menu bar "Charge tank" = "Yes".
- "SmartGrid Low price" or "SmartGrid Overcap." is active and a temperature increase via SmartGrid is set in the lower tank.
- The heat pump charges the buffer tank and the temperature in the lower tank is 5 °C higher than the previous set point* and the temperature in the buffer tank is 5 °C lower than the previous set point*.

Overcharging to the buffer tank continues until:

- The heat pump stops charging the lower tank (the need to charge the tank has disappeared).
- The temperature in the lower tank has dropped to the setpoint.
- "SmartGrid Low Price/Overcap." is not active.

Block diff thermostat No (No/Yes)

"Yes" means the function can be activated via remote control.

Block diff th. schedule

Access function scheduling.

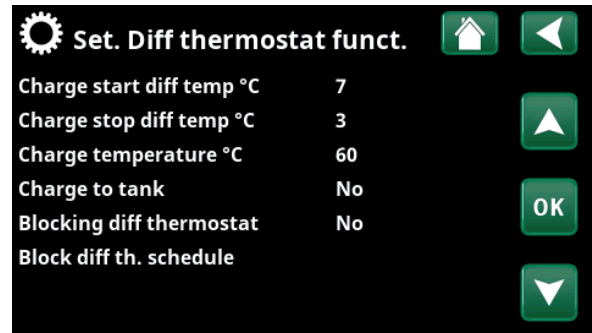

Menu: "Installer/Settings/Diff thermostat function".

**Previous setpoint means the setpoint before "SmartGrid Low Price" or "SmartGrid Overcap." was activated.*

9.9.7 Settings Cooling

Room temp. cooling °C 25.0 (18...30)

This is used to set the desired room temperature for cooling.

Active delay 10 (Off/1...600)

Delay refers to the time (minutes) before the production of cooling is allowed when there is a need for cooling.

Start delay 180 (Off/1...240)

The menu determines the delay time (minutes) from the time the cooling has been blocked (see menu bars "Ext. block cooling" and "Block cooling schedule") until the production of cooling is permitted again.

SmartGrid Low price °C Off (Off/1...5)

The setpoint for room temperature is decreased by the value set in this menu when "SmartGrid Low price" is active.

The menu bar is displayed if SmartGrid have been defined in the "Installer/Define/Remote Control" menu.

Read more in the "Remote Control/SmartGrid" section of the "Installer/Define" chapter.

SmartGrid Overcapacity °C Off (Off/1...5)

The setpoint for room temperature is decreased by the value set in this menu when "SmartGrid Overcapacity" is active.

The menu bar is displayed if SmartGrid have been defined in the "Installer/Define/Remote Control" menu.

Read more in the "Remote Control/SmartGrid" section of the "Installer/Define" chapter.

Ext. block cooling No (No/Yes)

Selecting "Yes" enables blocking of cooling. The function can be used to turn off cooling with the help of a humidity sensor when there is a risk of condensation.

Block cooling schedule

This menu is used to schedule the weekday periods during which cooling should be blocked. This schedule is repeated every week.

This menu bar is displayed if a "Schedule" has been defined for the "Block Cooling" function.

For more information, refer to:

- chapter "Schedule".
- section "Def. Remote Control" of the "Installer/Define" chapter for defining the remote control function.

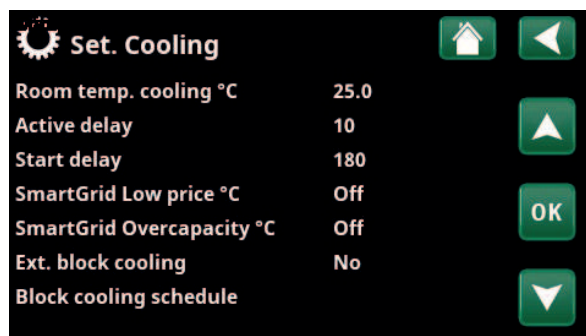

Menu: "Installer/Settings/Cooling".



A room sensor must always be used in that part of the property which is to be cooled, as it is the room sensor which determines/controls cooling capacity.

9.9.8 Settings Communication

Settings can be made here to control the product with a controlling system.

9.9.8.1 Settings Ethernet

DHCP Yes (Yes/No)

"Yes" enables automatic connection to the network.

If "No", custom router settings (IP address, Netmask and Gateway) as well as DNS setting must be made.

Auto DNS Yes (Yes/No)

If "Yes", default DNS server settings are used. If "No", custom DNS settings must be made.

SNTP Server

Option for custom SNTP server settings.

Connection speed 100mbit

Connection speed is specified here.

The factory-set connection speed is 100 mbit/s.

 For more information about connecting an ethernet cable, refer to the "Installation, Communication" chapter of this manual.

9.9.8.2 Settings BMS

MB address 1 (1...255)

Adjustable "1-255".

Baudrate 9600 (9600/19200)

Possible settings: "9600" or "19200".

Parity Even (Even/Odd/None)

Possible settings: "Even", "Odd" or "None".

Stop bit 1 (1/2)

Possible settings: 1 or 2.

Modbus TCP Port 502 (1...32767)

This menu bar is displayed if "Modbus TCP" is defined in the "Ethernet" row in the "Installer/Define/Remote Control" menu.

9.9.8.3 myUplink

The menu is used for pairing with the myUplink app. Request connection string by pressing "Get connection string", confirm with "OK". The menu bar is clickable if the display is connected to the server.

In the app: Scan the QR code or enter values for "Serial number" and "Connection string".

Select the menu items "Remove users" and / or "Remove service partners" to disconnect these accounts from the system. Confirm with "OK".



Menu: "Installer/Settings/Communication".

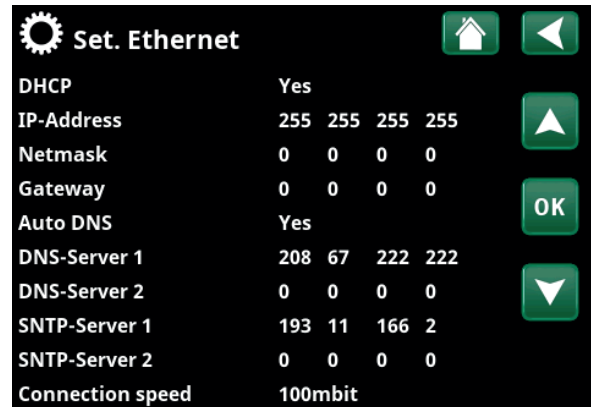

Menu: "Installer/Settings/Communication/Internet".

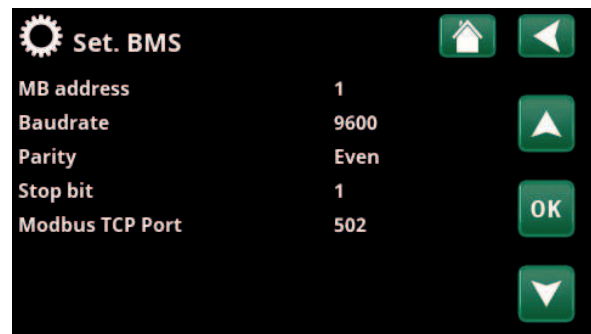

Menu: "Installer/Settings/Communication/BMS".



Menu: "Installer/Settings/Communication/myUplink".

9.9.8.4 Settings El. prices

Ensure that "myUplink" is selected in the "Def. Communication" menu.

Select "El.prices" in the "Installer/Settings/Communication" menu to access the "Set. El.prices" menu.

Price control On/Off

Select "On" to show the other menu lines of the "Set. El.prices" display menu.

Regions SE01/SE02/SE03/SE04

Click "OK" on the "Regions" line. If "Regions" are defined for the selected country (see "Installer/Display/Country" menu), price regions for the country are shown here. Otherwise, the text "No regions available" is displayed. In this example, Swedish price regions are displayed.

Dynamic Yes/No

"Yes" means that the electricity prices are calculated according to price algorithms that define the price categories ("High", "Medium" and "Low").

Click "OK" on the "Preview data" line to display a graph of electricity prices calculated over the selected time interval ("Days in calculation").

The graph can also be displayed by clicking the "El.prices" icon in the "Operation" main menu (see "Operation" section).

Limit value high

Set the limit value above which the electricity price is defined as "High" (in the example, the limit value is SEK 3.50). This can be used together with the dynamic price calculation feature to define a different "High" price range than that determined by the dynamic price calculation feature.

Prices defined as "High" activate the "SmartGrid Blocking" function.

Limit value low

Set the limit value below which the electricity price is defined as "Low" (in the example, the limit value is SEK 1.50). This can be used together with the dynamic price calculation feature to define a different "Low" price range than that determined by the dynamic price calculation feature.

Prices defined as "Low" activate the "SmartGrid Low price" function.

Default High/Medium/Low

Select the price category that should apply if prices cannot be retrieved.

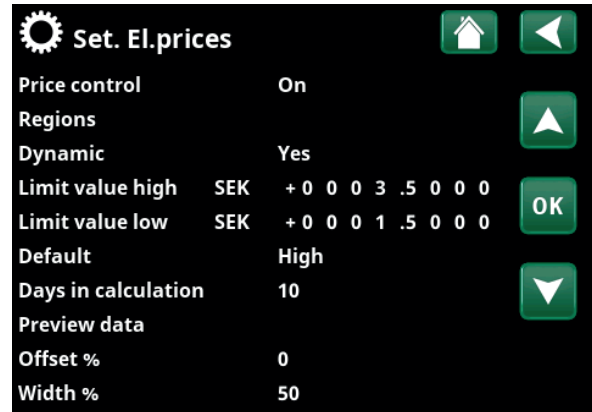

Menu: "Installer/Settings/Communication/El.prices" where "Installer/Define/Communication/myUplink:Yes" is selected.

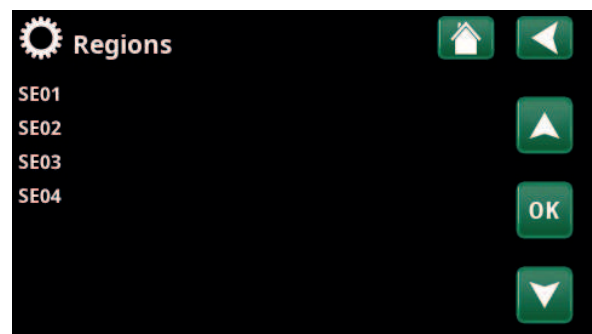

Menu: "Installer/Settings/Communication/El.prices/Regions" where "Installer/Define/Communication/myUplink:Yes" is selected

For more information and examples of Smart Electricity Price Control/SmartGrid, see the website www.ctc-heating.com/Products/Download.

Days in calculation

1...10

Select the number of days on which the dynamic calculation of the electricity price will be based. Since the dynamic calculation is based on the average price per day, more days in calculation result in a more stable and reliable value.

See also the "Example: Electricity price settings" section.

Preview data

Click "Preview data" to show electricity prices during the selected period in graph form.

Offset %

0 (0...100)

Enter code "4003" in the "Installer/Service/Coded settings/Code" menu to display the "Offset %" menu line.

"Offset" is the boundary between where "High" price and "Medium" price electricity is determined and is based on the average price for the number of days used in the calculation.

See also the "Example: Electricity price settings" section.

Width %

50 (0...200)

Enter code "4003" in the "Installer/Service/Coded settings/Code" menu to display the "Width %" menu line.

"Width" is the vertical price range where the electricity price is considered "Medium".

See also the "Example: Electricity price settings" section.

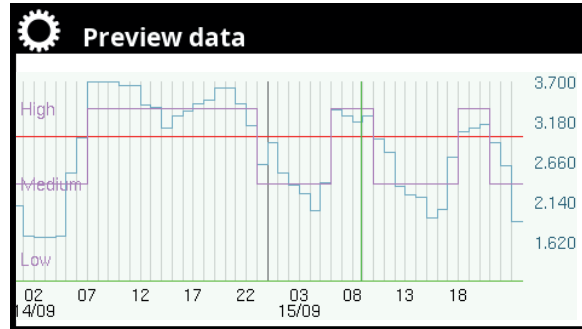

Menu: "Installer/Settings/Communication/El.prices/Preview data".

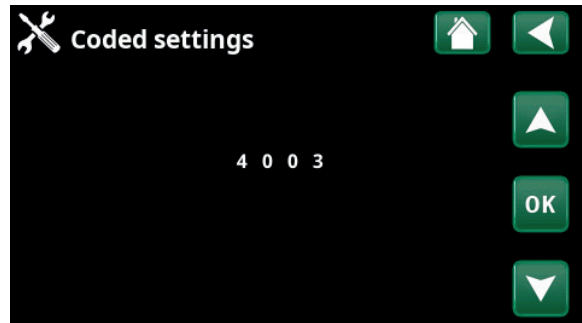

Menu: "Installer/Service/Coded settings/Code".

9.9.9 Settings Current sensor

These menu bars are displayed if "Current Sensor" is defined in the "Installer/Define Current Sensor" menu.

In the menu, specify the phases (L1, L2 and L3) to which the current sensors have been connected.

In the lower left corner of the screen, "Invalid configuration" will be displayed until L1, L2, and L3 are paired with the three current sensors in the menu.

When activating the "Auto config. current sensors" function, it is important that you have switched off all devices in the house that consume high levels of electricity. Also make sure that the backup thermostat is switched off.

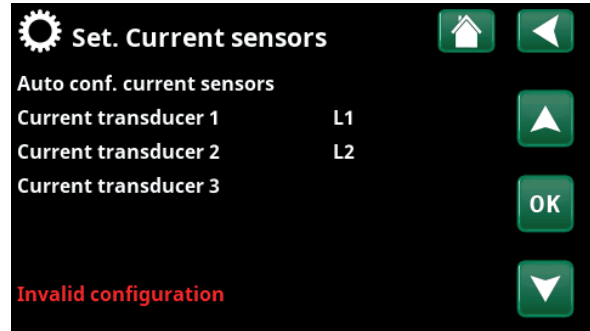

Menu: "Installer/Settings/Current Sensors".

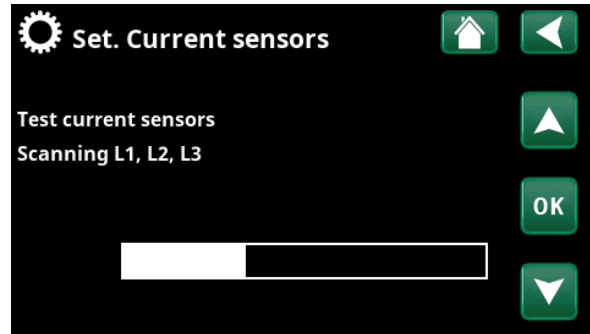

Menu: "Installer/Settings/Current Sensors /Auto config. current sensor".

9.9.10 Settings Round circulation schedule

Round circulation is equipment which an electricity supplier can fit in order to disconnect, for a short period of time, equipment which draws high current. The compressor and electrical output are blocked when Round circulation is active.

This menu bar is displayed if a schedule has been defined for the "Round circulation" function.

The "Round circulation" function can also be controlled remotely by activating the "Input" defined for the function.

For more information, refer to:

- chapter "Schedule".
- section "Def. Remote Control" of the "Installer/Define" chapter for defining the remote control function.

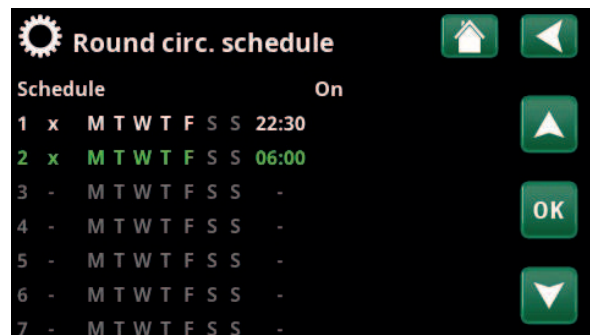

Menu: "Installer/Settings/Round circulation".

9.9.11 Settings SmartGrid schedule

This menu is used to schedule the weekday periods during which the "SmartGrid" functions should be active. This schedule is repeated every week.

"SmartGrid" can be used to block a function ("SG Block.") or to achieve a temperature increase during periods when the energy price is low ("SG Low price") or ("SG Overcapacity").

SG Normal mode can be used to easily deviate from any SmartGrid settings for the system on specific days/at specific times.

The "SmartGrid schedule" menu bar is displayed if a schedule has been defined in the "SmartGrid A" row.

For more information, refer to:

- chapter "Schedule".
- chapter "Installer/Define/Remote Control" for defining SmartGrid.

9.9.12 Save settings

Custom settings can be saved to "Bank" 1-3 and on a USB drive here. The "USB" row is greyed out until the USB drive is installed. The rows show the date and time of saved settings.

Press "OK" to confirm.

9.9.13 Load settings

The saved settings can be recovered.

Press "OK" to confirm.

9.9.14 Load Factory settings

The product is supplied with the factory values set. Saved settings in "Bank" 1-3 are deleted when factory settings are restored. The selected language is recovered.

Press "OK" to confirm.



Menu: "Installer/Settings/SmartGrid schedule".

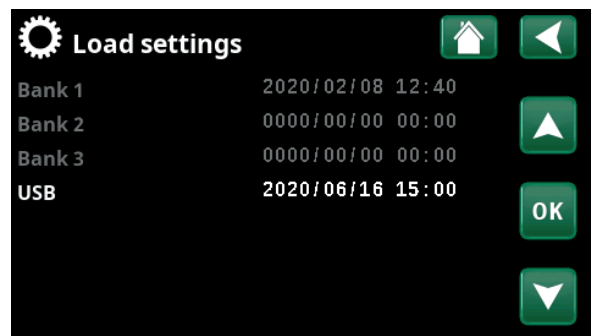

Menu: "Installer/Settings/Load My Settings".



9.10 Define

The "Define" menus specify which components and subsystems the system consists of.

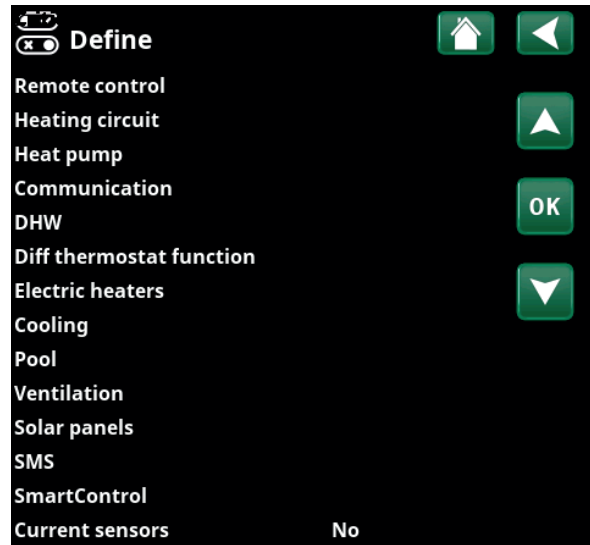

Menu: "Installer/Define".

9.10.1 Def. Remote control

This chapter describes all remote control functions; how they are set up and how they are used.

The "Installer/Define/Remote Control" menu defines how the remote control inputs should be activated by specifying one of the following three modes of activation in the "Input" column of this menu:

- a terminal block K22-K23 on the relay card (A2) has power or terminal block K24-K25 is closed. There are two 230 V inputs and two low voltage ports. See table below.
- wireless accessories in the CTC SmartControl series consist of wireless sensors and control units that control signals for temperature, humidity and carbon dioxide level.
- BMS control where control signals are transmitted via the BMS interface.

If you want a function to recur during weekdays, you can set when the function should be active/inactive in a schedule.

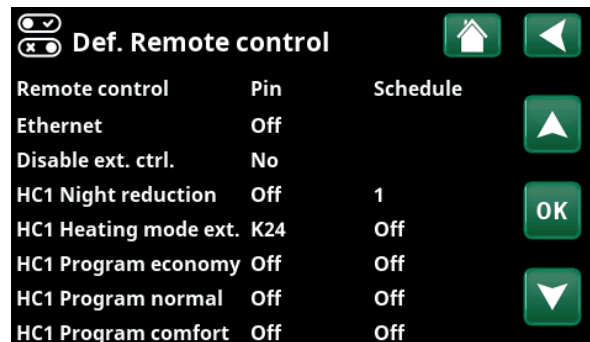

Part of the "Installer / Define/Remote Control" menu.

Designation	Terminal block position	Connection type
K22	A14 & A25	230V
K23	A24 & A25	230V
K24	G33 & G34	Extra-low voltage (<12V)
K25	G73 & G74	Extra-low voltage (<12V)

The table shows the remote control inputs K22-K25 on the relay card.

9.10.1.1 Setting the remote control function, example

1. Define an "Input"

First, an input must be assigned to the function or functions to be controlled remotely. This is done in the "Installer/Define/Remote Control" menu.

In the example, terminal block K24 is selected as the input for the "HC1 Heat Mode, Ext." function.

2. Configure the function (Normally Open (NO)/Normally Closed (NC))

Define a normal mode for the external control signal; NO or NC. The setting is made for the current heating circuit in the "Installer/Define/Heating Circuit" menu.

For example, a two-way switch can be connected to the defined input.

If the button when used generates a control signal on the input (circuit closes), the circuit shall be defined as NO. When the circuit closes and the control signal is generated, the heating mode selected in the "HC1 Heating mode, ext." row is activated in the settings menu for the heating circuit.

3. Setting the heating mode

In the example, the remote control function "Heating mode, ext." is set to the "Off" position in the "Heating mode, ext." row. This setting is made in the "Installer/Settings/heating circuit" menu.

In this example, the normal heating mode is active ("On").

When input K24 is closed (the multi-button in the example generates a control signal), the status of the Heating Mode (normal mode "On" > mode "Off") changes.

Heating remains off until you choose to start the heating (normal mode "On") by opening terminal block K24 (no signal on the terminal block).

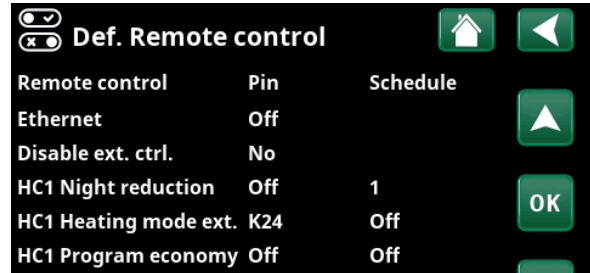

Menu: "Installer/Define/Remote Control".
Remote control function "HC1 Heating mode, ext." is assigned to terminal block "K24".

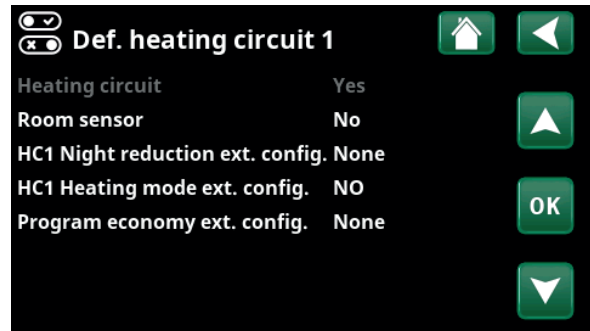

Menu: "Installer/Define/Heating Circuit/ Heating Circuit 1".
The normal mode of the remote control signal is defined in the "HC1 Heating mode ext. config" row.

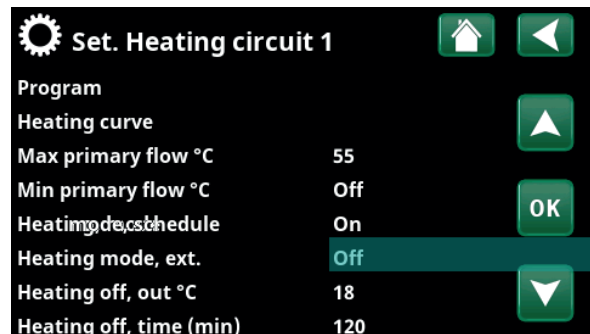

Menu: "Installer/Settings/Heating Circuit/ Heating Circuit 1" Remote control mode "Off" becomes active when terminal block K24 closes.

Open terminal block = Heating mode "On" (in this example).
Closed terminal block = Heating mode "Off" (in this example).

9.10.1.2 Remote control functions

The "Installer/Define/Remote Control" menu defines Inputs for current remote control functions:

- Inputs K22, K23, K24, K25.
- wireless accessories in the SmartControl series (Channel 1A, 1B, 2A, 2B, 3A, 3B and so on up to 7B).
- BMS digital input 0-7. Specify a value 0-255. The value must be set again within half an hour for the setting to persist.

Ethernet (Modbus TCP/Off)

For information about Modbus TCP Port settings, refer to the "Communication" section in the "Installer/Settings" chapter.

Disable ext. control (Yes/No)

Selection "Yes" means disconnecting all external control of the heat pump. Schedule settings are not affected.

HC1- Night reduction (Off/K22-K25/Channel 1A-7B / BMS DI0-7)

The "Night Reduction" function can be used to, for example, lower the indoor temperature during the night or during working hours.

In the "Installer / Define/Remote Control" menu:

- specify an "Input" for the remote control function.

In the "Installer / Define/Heating Circuit" menu:

- configure the normal mode for the external control signal (Normally Open (NO)/Normally Closed (NC)).

The schedule can be set in the "Heating/Cooling" menu.

For more information, refer to the "Night Reduction Temperature" section in the "Heating/Cooling" chapter.

HC1- Heating mode, ext. (Off/K22-K25/Channel 1A-7B / BMS DI0-7)

Switching between heating season and summer season can take place at a specific outdoor temperature (Auto) or heating can be either always "On" or "Off".

In the "Installer/Define/Remote Control" menu:

- specify an "Input" for the remote control function.

In the "Installer / Define/Heating Circuit" menu:

- configure the normal mode for the external control signal (Normally Open (NO)/Normally Closed (NC)).

In the "Installer/Settings/Heating Circuit" menu:

- set "Remote Control Mode" ("On", "Off" or "Auto") in the "Heating mode, ext." row.

Access function scheduling from the "Heat mode, schedule" row.

For more information, refer to the "Heating Circuit" section in the "Installer/Settings" chapter. Also refer to the "Your home's heating settings" chapter.

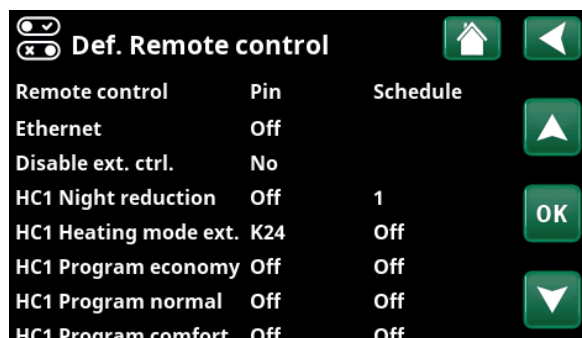

Part of the "Installer / Define/Remote Control" menu. "Input" and "Schedule" are defined here.

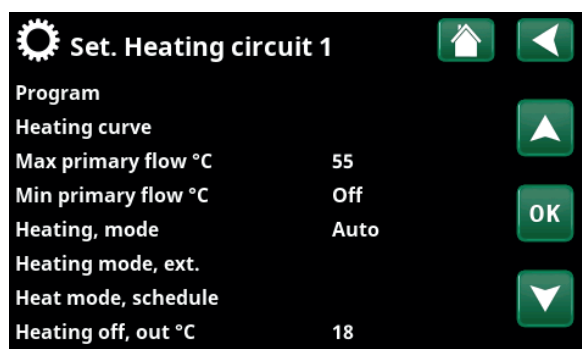

Menu: "Installer/Settings/Heating Circuit". The remote control mode for the heating circuit is set on menu bar "Heating mode, ext.". Access the schedule from the menu bar "Heating mode, schedule".

HC1- Program economy/normal/comfort/custom ext. config. (Off/K22-K25/Channel 1A-7B / BMS DI0-7)

The program functions "Economy", "Normal" "Comfort" and "Custom" can be used to change the indoor temperature for a certain period.

In the "Installer/Define/Remote Control" menu:

- specify an "Input" for the remote control function.

In the "Installer/Define/Heating circuit":

- configure the normal mode for the external control signal (Normally Open (NO)/Normally Closed (NC))

Setting the schedule is done from the "Heating/Cooling/Program" menu.

For more information, see section "Heating program" in chapter "Heating/Cooling".

Extra DHW (Off/K22-K25/Channel 1A-7B / BMS DI0-7)

Upon activation, production of extra DHW begins. When activation stops, extra DHW is produced for a run-on time of 30 min. The "Stop temperature" for extra DHW is set in the "Installer/Settings /DHW Tank/DHW program" menu.

In the "Installer/Define/Remote Control" menu:

- specify an "Input" for the remote control function.

In the "Installer/Define/DHW" menu:

- configure the normal mode for the external control signal (Normally Open (NO)/Normally Closed (NC)) in the "Extra DHW" row.

Setting extra DHW production to start immediately can also be done in the "DHW" menu. The schedule for extra DHW can also be set in this menu.

For more information, refer to the "Extra DHW" section in the "DHW" chapter.

For more information, refer to the "Upper Tank" section in the "Installer/Settings" chapter.

Block cooling

(Off/K22-K25/Channel 1A-7B / BMS DI0-7)

In the "Installer/Define/Remote Control" menu:

- specify an "Input" for the remote control function.

In the "Installer/ Define/Cooling" menu:

- configure the normal mode for the external control signal (Normally Open (NO)/Normally Closed (NC)).

In the "Installer/Settings/Cooling" menu:

- set the "remote control mode" ("On") in the "Block. cooling config." row.

Access function scheduling from the "Block. ext. config." row.

For more information, refer to the "Cooling" section in the "Installer/Settings" chapter.

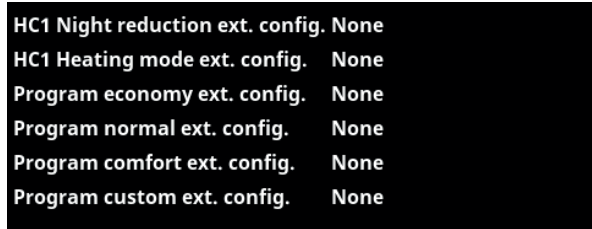

Menu "Installer/Define/Heating circuit". In the menu bars "Program economy / normal / comfort / custom ..." the normal mode is indicated on the external control signal ("Normally Open (NO)" or "Normally Closed (NC)").



Menu: "Installer/Define/DHW" On menu bar "Extra DHW", the normal mode is specified for the external control signal ("Normally Open (NO)" or "Normally Closed (NC)").

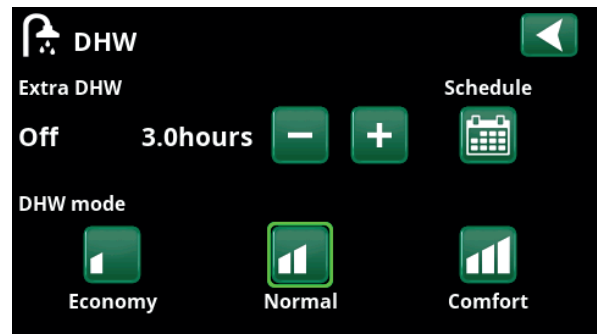

Setting the "Extra DHW" in the "DHW" menu.

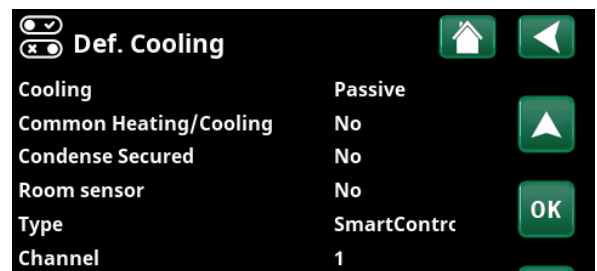

On menu bar "Block. cooling ext. config.", the normal mode is specified for the external control signal ("Normally Open (NO)" or "Normally Closed (NC)").

Tariff EL (Off/K22-K25/Channel 1A-7B / BMS DI0-7)

This function is used to block the electric heater during periods when the electricity rate is higher.

In the "Installer/Define/Remote Control" menu:

- specify an "Input" for the remote control function.

In the "Installer/Settings/Additional Heat" menu:

- set "remote control mode" ("Yes") in the "Tariff EL" row.

Access function scheduling from the "Tariff EL" row.

For more information, refer to the "Additional Heat/Tariff EL" section in the "Installer/Settings" chapter.

Round circulation

(Off/K22-K25/Channel 1A-7B / BMS DI0-7)

Round circulation is equipment which an electricity supplier can fit in order to disconnect, for a short period of time, equipment which draws high current. The compressor and electrical output are blocked when round circulation is active.

In the "Installer/Define/Remote Control" menu:

- specify an "Input" for the remote control function.

In the "Installer/Settings" menu:

- Access function scheduling from the "Round circulation" row.

For more information, refer to the "Round circulation" section in the "Installer/Settings" chapter.

Flow/level switch

(Off/K22-K25/Channel 1A-7B / BMS DI0-7)

The flow/level switch produces an alarm on the heat pump.

In the "Installer/Define/Remote Control" menu:

- specify an "Input" for the remote control function.

In the "Installer/Define/Heat Pump" menu:

- configure the normal mode for the external control signal (Normally Open (NO)/Normally Closed (NC)) in the "Flow/level switch" row.

Current sensors

Round circ. schedule

SmartGrid Schedule

Menu: "Installer/Settings". Setting a "Round circulation" schedule.

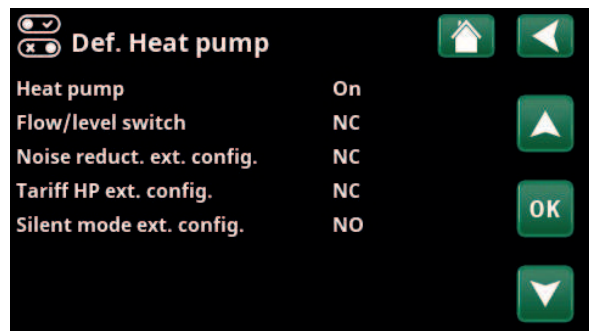

Menu: "Installer/Define/Heat Pump".

A mode for the external control signal ("Normally Open (NO)" or "Normally Closed (NC)").

SmartGrid A / SmartGrid B
(Off/K22-K25/Channel 1A-7B / BMS DI0-7)

In the "Installer/Define/Remote Control" menu:

- specify an "Input" for the remote control function.

There are three SmartGrid functions:

- SmartGrid Low Price
- SmartGrid Overcapacity
- SmartGrid Blocking

Example of "SmartGrid Low Price" for pool heating

In this example, "SmartGrid A" and "SmartGrid B" have been assigned terminal blocks K22 and K23, respectively. In addition, SmartGrid A is assigned "Schedule #1".

According to the settings in the "Set. Pool" menu, the pool setpoint will be increased by 5°C when the electricity price is low (when the "SmartGrid Low price" function is active) and the setpoint will be decreased by 10°C* when the electricity price is high (when the "SmartGrid Blocking" function is active).

SmartGrid functions can be set (depending on system configuration/heat pump model) for Heating circuit including Heating program economy/comfort/custom, Heat pumps, Additional heating, Cooling, Pool, DHW tank, Buffer tank and Upper* and Lower* tank.

Heating circuit 1-*

- SmartGrid Blocking (Off/On)
- SmartGrid Low price °C (Off/1...5 °C)
- SmartGrid Overcapacity °C (Off/1...5 °C)

Heating program

-Comfort:

- SmartGrid Low price °C (Off/On)
- SmartGrid Overcapacity °C (Off/On)

-Custom:

- SmartGrid Low price °C (Off/On)
- SmartGrid Overcapacity °C (Off/On)
- SmartGrid Blocking (Off/On)

-Economy:

- SmartGrid Blocking (Off/On)

Heat pump*

- SmartGrid Blocking HP (Yes/No)

Additional Heat/Electric Heater

- SmartGrid Blocking EL (Yes/No)
- SmartGrid Blocking Mixing valve (Yes/No)

Cooling

- SmartGrid Low Price °C (Off/1...5 °C)
- SmartGrid Overcapacity °C (Off/1...5 °C)

Pool

- SmartGrid Blocking °C (Off/-1...-50 °C)
- SmartGrid Low Price °C (Off/1...50 °C)
- SmartGrid Overcapacity °C (Off/1...50 °C)



Menu: "Installer/Settings/Pool".
The pool temperature is increased by 5 °C when the SmartGrid Low Price function is activated.

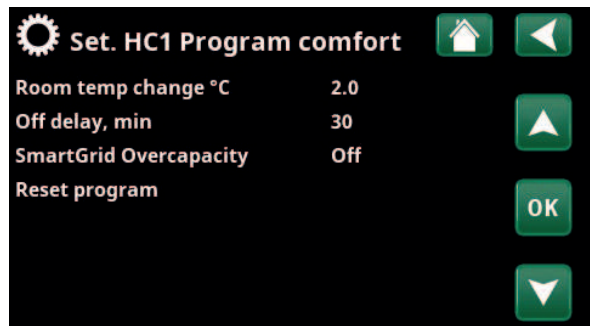

Menu "Installer/Settings/Heating Circuit/Heating Circuit 1/Program/Comfort".

*The heat pump can control up to 2 heating circuits.

DHW tank/Lower tank/Upper tank

- SmartGrid Blocking °C (Off/-1...-50 °C)
- SmartGrid Low Price °C (Off/1...30 °C)
- SmartGrid Overcapacity °C (Off/1...30 °C)

Buffer tank

- SmartGrid Low Price °C (Off/1...30 °C)
- SmartGrid Overcapacity °C (Off/1...30 °C)

SmartGrid functions are enabled by activating the SmartGrid inputs in different ways according to the table on the right.

To enable the SmartGrid function "SG Low price" as shown in the example, terminal block K23 must have power while terminal block K22 should remain unchanged.

The pool temperature increase that will apply when "SG Low price" is activated is set in the "Pool Settings" menu, as shown in the example.

Alternatively, a schedule can be set up for periodic SmartGrid activation. For more information on setting schedules, refer to the "Schedule" section.

K22 (SG A)	K23 (SG B)	Function
Open	Open	Normal
Open	Closed	Low price
Closed	Closed	Overcapacity
Closed	Open	Blocking

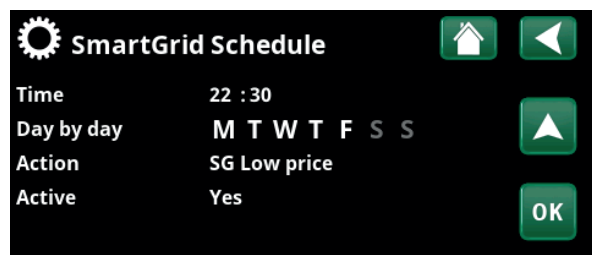

The schedule is set to start at 22:30, weekdays.

Tariff HP

(Off/ K22-K25/Channel 1A-7B / BMS DI0-7)

This function is used to block the heat pump during periods when the electricity rate is higher.

In the "Installer/Define/Remote Control" menu:

- specify an "Input" for the remote control function.

In the "Installer/Define/Heat Pump" menu:

- configure the normal mode for the external control signal (Normally Open (NO)/Normally Closed (NC)) in the "Tariff HP ext. config." row.

In the "Installer/Settings/Heat Pump" menu:

- set "Tariff HP" ("On").

For more information, refer to the "Heating Pump" section in the "Installer/Settings" chapter.

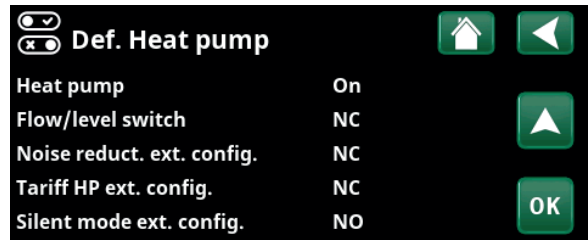

Menu: "Installer/Define/Heat Pump".
A mode for the external control signal ("Normally Open (NO)" or "Normally Closed (NC)") is defined for "Tariff HP ext. config.", "Noise reduction ext. config." and "Silent mode ext. config.".

Diff thermostat function

(Off/ K22-K25/Channel 1A-7B / BMS DI0-7)

This function is used to block the diff thermostat function.

In the "Installer/Define/Remote Control" menu:

- specify an "Input" for the remote control function.

In the "Installer/Define/Diff thermostat function" menu:

- configure the normal mode for the external control signal (Normally Open (NO)/Normally Closed (NC)) in the "Blocking diff thermostat ext. config." row.

For more information, refer to the "Diff thermostat function" section in the "Installer/Settings" chapter.

9.10.2 Def. Heating Circuit

Heating Circuit 1 Yes (Yes/No)

Heating Circuit 1 (HC 1) is predefined by the control system. Heating Circuit 2 is shown on the row underneath if connected.

Room sensor Yes (Yes/No/Show)

Selection "Yes" means that room sensors should be connected to the heating circuit.

If "Show" is selected, the room temperature is displayed but the room sensor is not used for control.

Type Wireless (Cable/Wireless/SmartControl)

Select whether the room sensor for the heating circuit has a wired (via cable) or wireless connection.

- **Wireless**
Select "Wireless" to connect CTC's wireless room sensors to the heating circuit. Refer to the "CTC Wireless Room Sensor" manual for information on how to connect these sensors.
- **SmartControl**
SmartControl is a separate series of wireless accessories. If "SmartControl" is selected, the connection channel must be selected in the row below. SmartControl accessories are connected to the system via the "Installer/Define/SmartControl" menu. Refer to the separate SmartControl Accessories manual.

HC1- Night reduction ext. config. None (None/NO/NC)

This menu defines the Normally Open (NO) or Normally Closed (NC) mode for the external control signal when remotely controlling the function.

For examples of how to set the normal mode, refer to the "Installer/Define/Remote Control" chapter.

HC1- Heating mode ext. config. None (None/NO/NC)

This menu defines the Normally Open (NO) or Normally Closed (NC) mode for the external control signal when remotely controlling the function.

For examples of how to set the normal mode, refer to the "Installer/Define/Remote Control" chapter.

Program * ext. config. None (None/NO/NC)
***economy/normal/comfort/custom**

This menu defines the Normally Open (NO) or Normally Closed (NC) mode for the external control signal when remotely controlling the function.

For examples of how to set the normal mode, refer to the "Installer/Define/Remote Control" chapter.

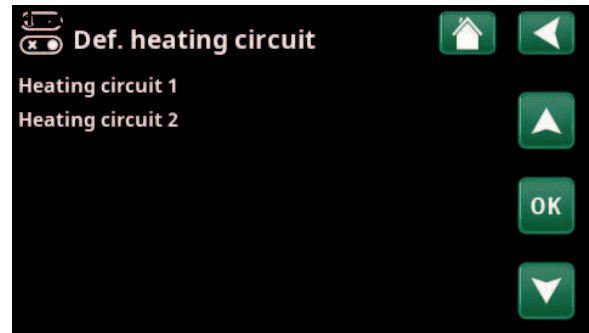

Menu: "Installer/Define/Heating Circuit".
Select a heating circuit and press "OK" to access the settings.

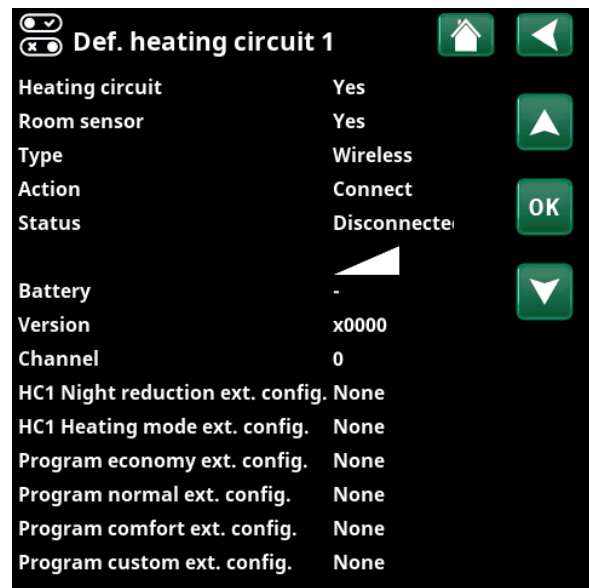

Menu: "Installer/Define/Heating Circuit/ Heating Circuit 1".
Wireless room sensor selected.

9.10.3 Def. Heat pump

Heat pump Off (On/Off)

Select whether the heat pump should be On or Off.

Flow/level switch None (None/NC/NO)

This menu bar is displayed if an "Input" for remote control is defined for the "Flow/level switch" function in the "Installer/Define/Define Remote Control" menu.

Tariff HP ext. config. None (None/NC/NO)

This menu bar is displayed if an "Input" for remote control is defined for the "HP Tariff" function in the "Installer/Define/Remote Control" menu.

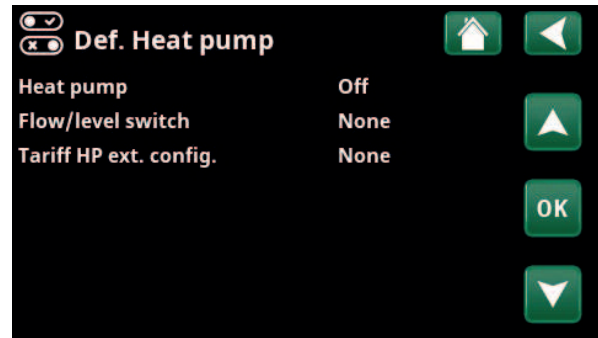

Menu: "Installer/Define/Heat Pump".

9.10.4 Def. Communication

myUplink No (Yes/No)

Select "Yes" to connect to the heat pump from the myUplink app.

Web No (Yes/No)

Select "Yes" to connect to the local web server. Internet router and firewall required.

El.prices myUplink/myUplink ext./BMS/No

Select "myUplink" to connect the heat pump to the myUplink mobile app for electricity price control.

Select "myUplink ext." to connect via myUplink to an external price control app. This option is not available at the moment.

Select "BMS" to connect via property management.



Menu: "Installer/Define/Communication".



For more information, see the "Installation Communication" chapter of this manual.

9.10.5 Def. DHW

Extra DHW ext. config. None (None/NC/NO)

This menu defines the Normally Open (NO) or Normally Closed (NC) mode for the external control signal when remotely controlling the function.

For examples of normal mode settings, refer to the "Def. Remote Control" section of the "Installer/Define" chapter.



Menu: "Installer/Define/DHW".

9.10.6 Def. Diff thermostat

Diff thermostat function No/Yes

If "Yes" is selected, the menu "Blocking diff thermostat ext. config." is displayed.

Blocking diff thermostat ext. config. None
(None/NC/NO)

This menu defines the Normally Open (NO) or Normally Closed (NC) mode for the external control signal when remotely controlling the function.

For examples of normal mode settings, refer to the "Def. Remote Control" section of the "Installer/Define" chapter.

9.10.7 Def. Electric heater

Tariff EL ext. config. None (NO/NC/None)

The function can block the electric heater at times of high electricity tariffs by means of an external signal.

This menu defines the Normally Open (NO) or Normally Closed (NC) mode for the external control signal when remotely controlling the function.

For examples of normal mode settings, refer to the "Def. Remote Control" section of the "Installer/Define" chapter.

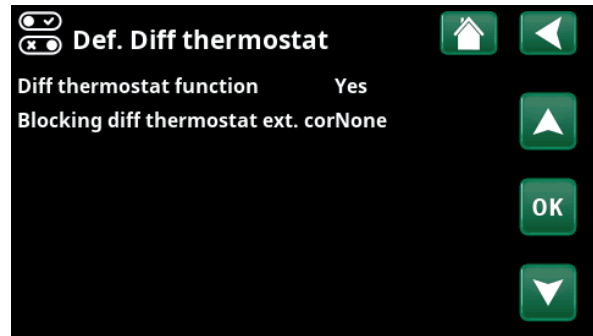

Menu: "Installer/Define/Diff thermostat".



Menu: "Installer/Define/Electric Heater".

9.10.8 Def. Cooling

Cooling is adjusted using primary flow sensor 2 (B2), which then means that heating circuit 2 and cooling cannot be used simultaneously.

Cooling **No (Passive/No)**

"Passive" means that cooling is used.

Common Heating/Cooling **No (Yes/No)**

"Yes" means that cooling and heating are distributed in the same heating circuit.

Condense secured **No (No/Yes)**

If the system is condensation-proofed, significantly lower temperatures are permitted at various points in the system. **WARNING!** Build-up of condensation in the house structure can lead to damp and damage from mildew.

"No" means a setting range for room temperature of 18-30 °C and "Yes" means a setting range of 10-30 °C.

In the event of doubt, contact a professional for an assessment.

Room sensor **Yes (Yes/No/Show)**

Selection "Yes" means that room sensors should be connected to the heating circuit.

If "Show" is selected, the room temperature is displayed but the room sensor is not used for control.

Type **Cable/Wireless/SmartControl**

Select whether the heating circuit room sensor is:

- **Cable**
Wired room sensor.
- **Wireless**
If "Wireless" is selected, CTC's wireless room sensors will connect to the heating circuit. Refer to the "CTC Wireless Room Sensor" manual for information on how to connect these sensors.
- **SmartControl**
SmartControl is a separate series of wireless accessories. If "SmartControl" is selected, the connection channel must be selected in the row below. These accessories must be connected to the heating circuit via the "Installer/Define/SmartControl" menu. Refer to the separate "Installation and Maintenance Manual" for the SmartControl accessory.

Block cooling ext. config. **None (None/NC/NO)**

This menu bar is displayed if an "Input" for remote control is defined for the "Block Cooling" function in the "Installer/Define/Remote Control" menu.

The function can be used to turn off cooling with the help of a humidity sensor when there is a risk of condensation. This menu defines the Normally Open (NO) or Normally Closed (NC) mode for the external control signal when remotely controlling the function.

For examples of normal mode settings, refer to the "Def. Remote Control" section of the "Installer/Define" chapter.

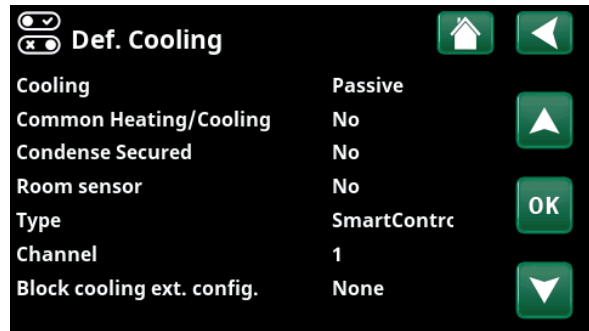

Menu: "Installer/Define/Cooling".



A room sensor must always be used in that part of the property which is to be cooled, as it is the room sensor which determines/controls cooling capacity.

9.10.9 Def. SMS

Activate **No (Yes/No)**

If "Yes" is selected, the menus below are displayed:

Level of signal

The signal strength of the reception is shown here.

Phone Number 1

The first activated phone number is shown here.

Phone Number 2

The second activated phone number is shown here.

Hardware Version

The hardware version of the SMS accessory is shown here.

Software Version

The software version of the SMS accessory is shown here.

NB: For more information about the SMS function, refer to the "Installation and Maintenance Manual" for CTC SMS.

9.10.10 Def. SmartControl

SmartControl is a separate series of wireless accessories.

SmartControl **No (Yes/No)**

If "Yes" is selected, SmartControl accessories can be connected to the heating circuit. Refer to the connection procedure in the separate SmartControl Accessories manual.

9.10.11 Def. Current sensor

Current sensor **Yes (Yes/No)**

Select "Yes" if current sensors are to be connected to the system.

For more information, refer to the "Current Sensors" section in the "Installer/Settings" chapter.

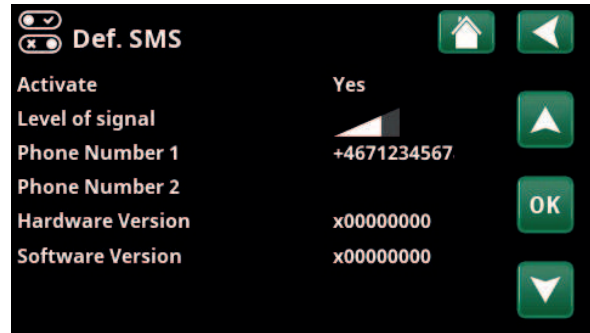

Menu: "Installer/Define/ SMS".

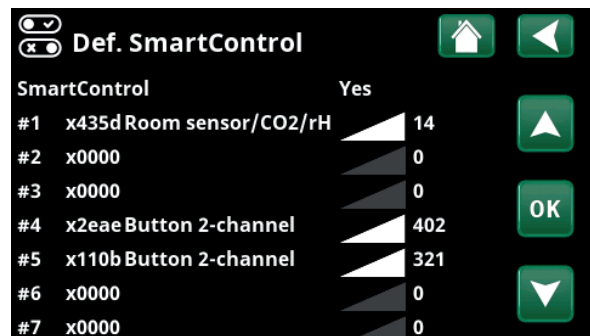

Menu: "Installer/Define/SmartControl".



9.11 Service



NB: This menu is intended for the installer only.

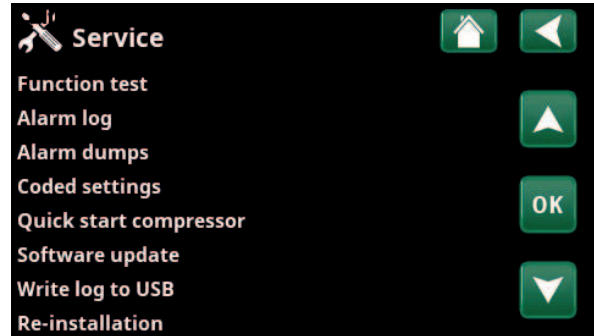

Menu: "Installer/Service".

9.11.1 Function test

From this menu, the installer can test the connection and function of separate components of the heating circuit. When this menu is activated, all control functions are stopped. The only protection against incorrect operation is the pressure sensors and the electric heater's overheating protection device. The heat pump returns to normal operation after 10 minutes of inactivity or when exiting the "Function Test" menu. When the menu is opened, all automatic functions are stopped and testing can be performed.



When you exit the menu, the heat pump returns to normal operation.

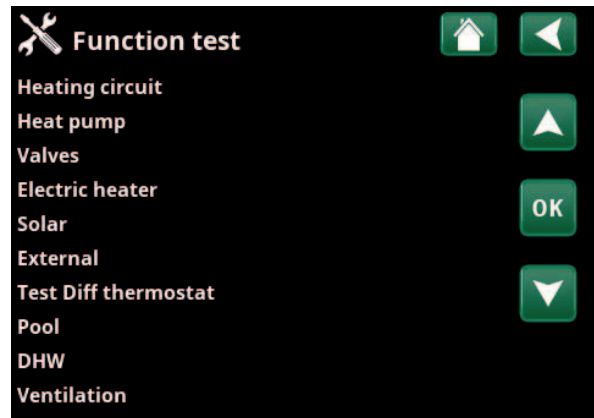

Menu: "Installer/Service/ Function Test".

9.11.1.1 Test Heating circuit

If several heating circuits have been installed, they will all be displayed here.

Mixing valve (1-) **Close (Close/Open)**

Opens and closes the respective mixing valve.

Rad pump (1-) **Off (On/Off)**

Starts and stops the respective radiator pump.

LED room sensor **Off (On/Off)**

The room sensor alarm functions can be controlled from here. When activated, the respective room sensor's red LED comes on steady.

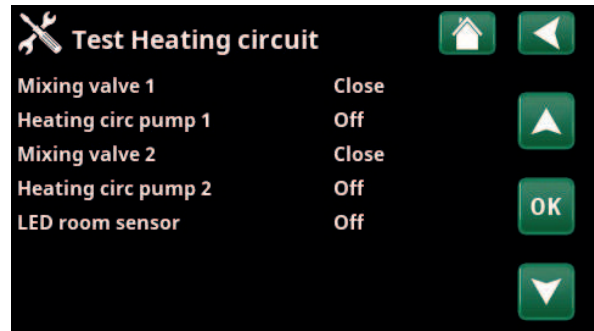

Menu: "Installer/Service/ Function Test/Heating Circuit".

9.11.1.2 Test Valves

The following valves are function tested from this menu:

3-way valve **Down (Up/Down)**

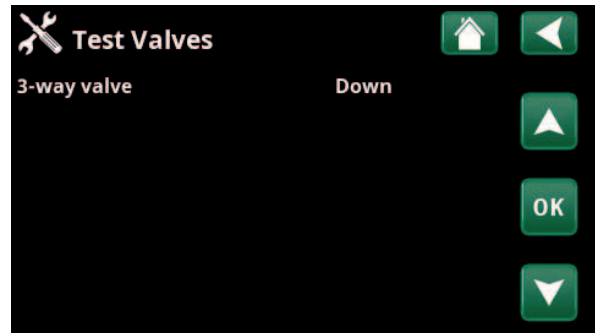

Menu: "Installer/Service/ Function Test/Valves".

9.11.1.3 Test Electric heaters

Tests the electric heaters per phase and step (on/off).

Electric heater L1A	Off (Off/On)
Electric heater L1B	Off (Off/On)
Electric heater L2A	Off (Off/On)
Electric heater L2B	Off (Off/On)
Electric heater L3A	Off (Off/On)
Electric heater L3B	Off (Off/On)

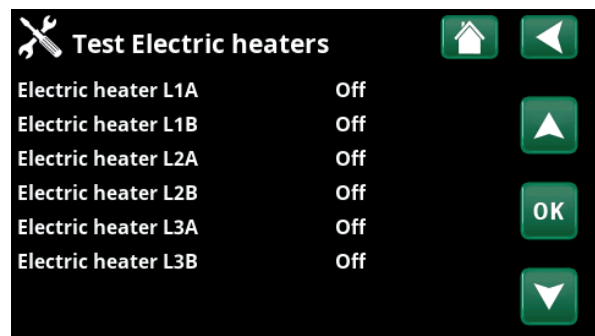

Menu: "Installer/Service/ Function Test/Electric Heaters".

9.11.1.4 Test Diff. thermostat

Pump H-tank (G46) **Off (Off/On)**

Function test of circulation pump to tank transfer.

Temperatures

This displays current temperatures.

• H-tank (B6)	67 °C
• Diff thermostat °C (B46)	68 °C

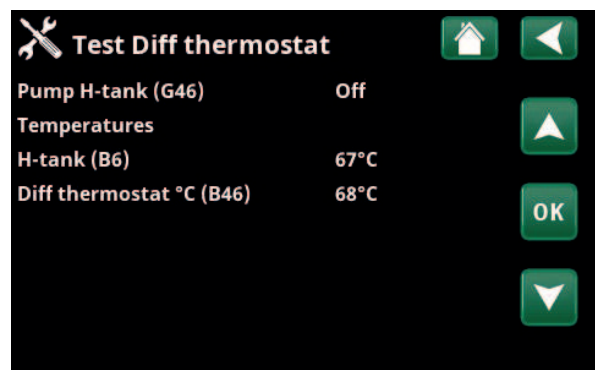

Menu: "Installer/Service/ Function Test/Diff Thermostat".

4.5.2 Alarm log

In the alarm log, up to 500 alarms can be displayed at the same time.

An alarm which reoccurs within an hour is ignored so as not to fill up the log.

Click an alarm row to see more information about an alarm.

If it is a "sensor alarm", a sensor value will be displayed at the bottom of the page from when the alarm was triggered for further troubleshooting.

For alarms related to the heat pump, values can be displayed from sensors for pressure (HP, LP), temperature (SH=Superheating) and current (I).

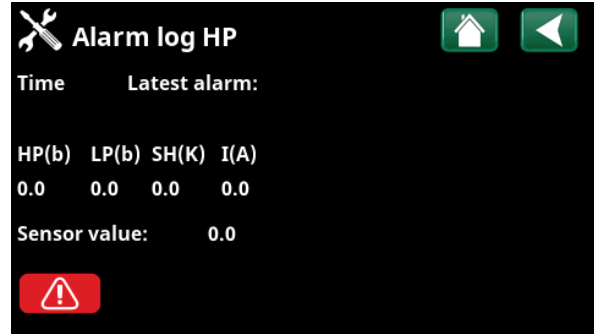

Menu: "Installer/Service/ Alarm log".

! NB: Only an authorised service engineer is allowed to log in to the Factory settings coded option. Severe operational problems and faults may occur affecting the product if values are amended without authorisation. Note that in such cases the warranty terms do not apply.

4.5.3 Alarm dumps

Export the alarms displayed in the alarm log to a USB drive. A dump can consist of one or more alarms as well as specific values before and after the alarm was triggered.

4.5.4 Coded settings

This menu is intended to set the manufacturer's operational and alarm limits. A 4-digit code must be specified to be able to amend these limits. However, you can also look without any code to see what options feature in the menu.

4.5.5 Quick start compressor

The delay normally prevents compressor start earlier than 10 mins after compressor stop. The delay is also activated in the event of a power failure, or the first time after production is started. This function speeds up this process.

For "System Types" 1 to 3, the degree minute loss is set to the value that starts all heat pumps.

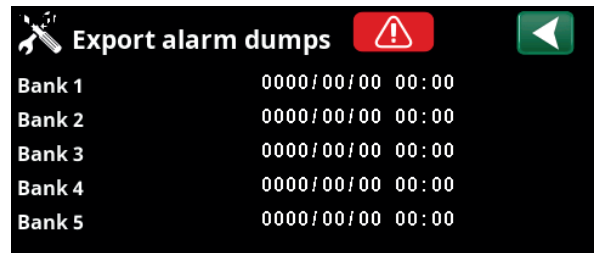

Menu: "Installer/Service/Alarm Dumps".

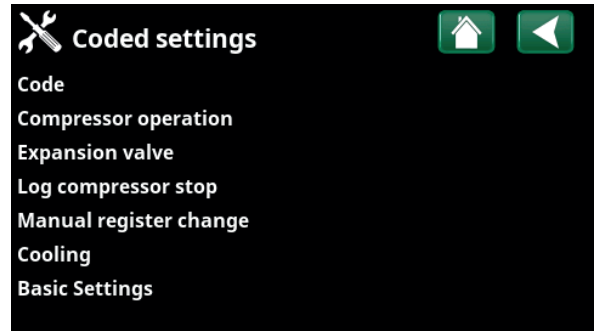

Menu: "Installer/Service/Coded settings".

4.5.6 Software update

The display software can be updated either via USB drive or online. The rows are greyed out until the USB drive is installed or the display is connected to the internet.

Click OK to confirm the upload.

The settings are retained during updating, but the old values are overwritten by any new factory values.

4.5.7 Write log to USB

Intended for service engineers. This function can be used to save logged values to a USB memory stick.

4.5.8 Re-installation

This command relaunches the installation sequence. First, confirm that you want to reinstall to access the installation wizard, refer to the "Installation Guide" and "First Start" chapters.

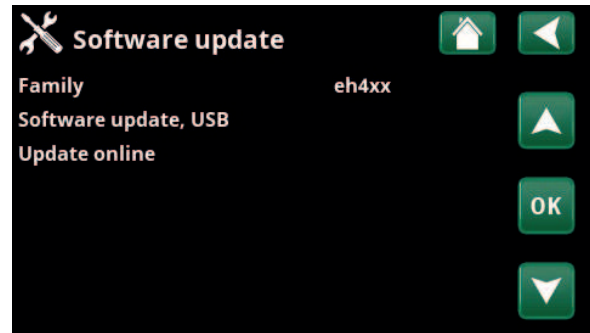

Menu: "Installer/Service/ Software Update".

! NB: The power to the product must not be interrupted, under any circumstances, during the update process.

! NB: Turn off the power and always restart the product after software update. Several minutes may pass before the display communicates clearly after restart.

10. Operation and Maintenance

When the installer has installed your new system, you should check along with the installer that it is in perfect operating condition. Let the installer show you where the switches, controls and fuses are so that you know how the system works and how it should be maintained. Bleed the heating circuit after around three days of operation and top up with water if required.

Boiler and heating circuit safety valve

Check around four times a year that the valve is working by manually turning the control. Check that water is coming out of the safety valve discharge.

Mixing valve

The mixing valve is operated automatically from the control system, so that the correct temperature, irrespective of the season, reaches the heating circuit. However, where a fault occurs, you can operate the valve by pulling out the knob on the motor and turning it clockwise to reduce the temperature or anticlockwise to increase it.

Draining the tank

The heat pump must be disconnected from power when draining. The drain valve is located at the bottom left when viewed from the front, behind the front of the heat pump. When draining the whole system, the mixing valve should be fully open, i.e. turned anticlockwise as far as it will go. Air must be supplied to the closed system.

Operation stop

The heat pump is shut down using the operating switch. If there is a risk of the water freezing, all the water should be drained from the boiler and the heating circuit (see drainage above).

The DHW circuit, which contains around five litres, must also be emptied. Disconnect the cold water connection on the heat pump and insert a hose. The hose must go down to the bottom of the coil for all the water to be drained. Draining is carried out by siphoning out the water.

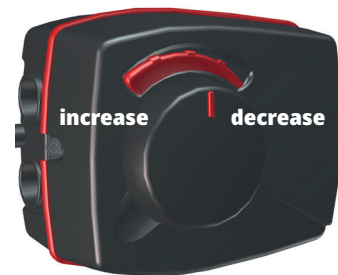

i Do not forget to reset the mixing valve to automatic mode by pushing in the knob again.

11. Troubleshooting/Appropriate measures

The heat pump is designed to provide reliable operation and high levels of comfort, and to have a long service life. Various tips are given below which may be helpful and guide you in the event of an operational malfunction.

If a fault occurs, you should always contact the installer who installed your unit. If the installer believes the malfunction is due to a materials or design fault, then they will contact Enertech AB to check and rectify the issue. Always provide the product's serial number.

DHW

Many people want to gain maximum benefit from the low operating costs of the heat pump. The control system is equipped with three comfort levels for DHW. We recommend starting at the lowest level and if there is not enough hot water, increase it to the next level. We also recommend that you operate a regular DHW pattern.

Check that the DHW temperature is not being affected by a poor mixing valve, whether at the heat pump or possibly the shower mixer.

The heating circuit

A room sensor, which should be fitted when possible, ensures that the temperature in the room is always suitable and stable. For optimal running, radiator thermostats should always be fully open in the area where the room sensor is located.

A correctly operating heating circuit is important to the heat pump's operation and affects energy savings.

When adjusting the system, always do so with all radiator thermostats fully open. The thermostats can be individually adjusted after a few days in rooms where lower temperatures are desired.

If you do not achieve the set room temperature, check:

- That the heating circuit is correctly adjusted and is functioning normally. That radiator thermostats are open and the radiators are equally warm all over. Touch the entire radiator surface. Bleed the heating circuit. The heat pump's economical operation requires that the heating circuit functions effectively.
- That the heat pump is in operation and no error messages are displayed.
- That there is enough electrical power available. Increase if necessary. Also check that the electric power output is not limited due to excessively high electricity loads in the property (load monitor).
- The product is set in "Max primary flow °C" mode with a too low set value.
- A sufficiently high value of "Max primary flow °C" has been selected at -15 °C outdoor temperature, increase if necessary. More can be read about this in the chapter on the "House heating curve". However, always check the other points first.
- That the temperature reduction is set correctly. See "Settings/Heating circuit".
- that the mixing valve is not in the manual position.

If the heat is not even, check:

- That the placement of the room sensors is appropriate for the house.
- That the radiator thermostats don't interfere with the room sensor.
- That no other heat sources/cold sources interfere with the room sensor.
- that the mixing valve is not in the manual position.

● Avoid running DHW at the highest flow capacity. If you run a bath at a rather slower rate instead, you will get a higher temperature.

● Avoid placing the room sensor close to the stairway due to the uneven air circulation.

● If you do not have radiator thermostats on the upper floor, you may need to install them.

Current monitor

The heat pump has an integrated current monitor. If the system is fitted with a current sensor, the property's main fuses are continuously monitored to ensure they are not overloaded. If the fuses are overloaded, the heat pump will automatically reduce its power output. The electrical output of the heat pump may be restricted where high heating requirement levels are combined with, for example, single-phase motor heaters, cookers, washing machines or tumble dryers. This may result in inadequate heating or DHW temperatures. If the heat pump is restricted, "High current, elpower reduced (X A)" appears in text form in the display. Consult an electrician to determine whether the fuse size is correct or the three phases in the house are evenly loaded.

Air problems

If you hear a rasping sound from the tank, check that it has been properly bled. Turn the boiler vent valve so that any air can be evacuated. Top up with water where required, so that the correct pressure is achieved. If this noise recurs, call a technician to check the cause.

Unusual noise when shutting off DHW

In some cases, unusual noises may be produced by the house's pipe system and the heat pump due to the pressure surges that occur when the flow is suddenly interrupted. There is no fault with the product, but the noise may occur when older types of instant closing mixers are used. More recent types are often fitted with a soft-closing mechanism. If an unusual sound comes from hard-closing dishwasher and washing machines, this can be remedied using a shock arrestor. A shock arrestor can also be an alternative to soft-closing water taps.

Motor protection (when heat pump is connected)

The heat pump constantly monitors the compressor's operating current and an alarm is triggered if the compressor is using an unusually high current. When a fault occurs the message "Motor protect high current" is displayed.

The cause of the fault may be as follows:

- Phase failure or mains interruption. Check the fuses, which are the most common cause.
- Compressor overload. Call out a service engineer.
- Faulty compressor. Call out a service engineer.
- Inadequate circulation between the heat pump and boiler. Check the heat medium pump (left pump, viewed from front). Call out a service engineer.
- Abnormally high temperature in the brine circuit. Call out a service engineer.

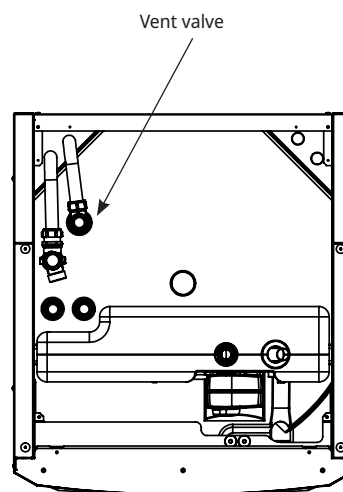

i Keep in mind that the heating circuit may also need bleeding.

11.1 Information messages

Information messages are displayed when appropriate and are intended to inform users about various operational situations.



[I002] HC1 Heating off

[I005] HC2 Heating off

Shows that the product is operating in summer-time mode when only DHW is required, not heating.

[I008] Tariff HP off

Indicates that Tariff has switched off the heat pump.

[I009] Compressor blocked

The compressor is set to be shut down, e.g. before drilling or digging has been carried out for the collector coils. The product comes with the compressor switched off. This option is selected in the "Installer/Settings/Heat Pump" menu.

[I010] Tariff EL Off

Shows that tariff has switched off the immersion heater elements.

[I011] Round circulation

Indicates that Round circulation is active. Round circulation is a device which can be fitted by an electricity supplier in order to disconnect equipment with a high rate of electricity consumption for a short period of time. Not currently in use in the UK. The compressor and electrical output are blocked when Round circulation is active.

[I012] High curr., reduced elec.

- The property's main fuses risk being overloaded due to, for example, the simultaneous use of several power-hungry appliances. The product reduces the electrical heaters' electrical output during this period.
- 2h max. 6 kW. Electric heating elements are limited to 6 kW for 2 hours after being switched on. This message appears if more than 6 kW are required during the product's first 2 hours of operation. This is applicable after a power outage or a new installation.

[I013] Start delay

The compressor is not allowed to start too quickly when it has stopped. The delay is usually approx. 10 minutes.

[I014] Drying period active, d

Indicates that the floor function is active and displays the time (days) remaining that the function will be active.

[I017] SmartGrid: Blocking

[I019] SmartGrid: Low price

[I018] SmartGrid: Overcapacity

Product functionality is governed by "SmartGrid". Also refer to the "Installer/Define/Remote Control/SmartGrid" menu.

[I021] Ext. Ctrl Heating 1

The remote control affects whether the heating is to be on or off. If the heating is switched off, "Heating off, heating circuit 1/2" is also displayed.

[I028] Holiday period

Displayed when setting the holiday schedule, which entails lowering the room temperature and that no hot water is produced.

[I030] Driver block under voltage

The heat pump has stopped due to insufficient mains voltage. The product will attempt to restart.

[I031] Driver block alarm

The heat pump has stopped due to driver failure; for example, voltage or excessive temperature. The product will attempt to restart.

11.2 Alarm messages

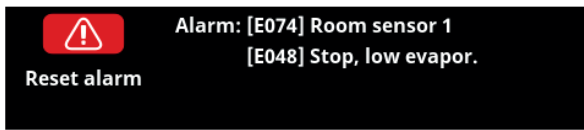

If a fault occurs with e.g. a sensor, an alarm is triggered. A message appears on the display with information about the fault.

You reset the alarm by pressing the Reset Alarm button on the display. If several alarms are triggered, they are displayed one after the other. A persisting fault must first be rectified before it can be reset. Some alarms are reset automatically if the fault ceases.

The description below also includes an alarm for connected heat pump.

Alarm messages	Description
[E010] Compressor type?	This message appears if no information about the compressor type is available.
[E013] EVO off	This message appears when there is a fault with the expansion valve control. Contact your installer.
[E024] Fuse blown	This message appears when the fuse (F1, F2) has blown.
[E026] Heat pump	This message appears if the heat pump is in alarm mode.
[E035] High pressure switch	The refrigerant's high pressure switch has been triggered. Press reset and check whether the alarm recurs. If the fault recurs, contact your installer.
[E040] Low brine flow	Low brine flow is often caused by air in the collector system, especially immediately following installation. Collectors which are too long can also be a cause. Also check that the brine pump is set to the fastest speed. Press reset and check whether the alarm recurs. Also check the brine filter that has been installed. If the fault recurs, contact your installer.
[E041] Low brine temp	Incoming brine temperatures from bore hole/ground loop are too low. Press reset and check whether the alarm recurs. If the fault recurs, contact your installer to check the dimensions of the cold side.
[E044] Stop, high compr temp	This message appears when the compressor temperature is high. Press reset and check whether the alarm recurs. If the fault recurs, contact your installer.
[E045] Stop, Low evaporation	This message appears when the evaporation temperature is low. Press reset and check whether the alarm recurs. If the fault recurs, contact your installer.
[E046] Stop, high evaporation	This message appears when the evaporation temperature is high. Press reset and check whether the alarm recurs. If the fault recurs, contact your installer.
[E047] Stop, low suct. gas exp. valve	This message appears when the suction gas temperature is low. Press reset and check whether the alarm recurs. If the fault recurs, contact your installer.
[E048] Stop, low evap. exp. valve	This message appears when the expansion valve's evaporation temperature is low. Press reset and check whether the alarm recurs. If the fault recurs, contact your installer.
[E049] Stop, high evap. exp. valve	This message appears when the expansion valve's evaporation temperature is high. Press reset and check whether the alarm recurs. If the fault recurs, contact your installer.
[E050] Stop, low overheat. exp. valve	This message appears when the expansion valve's overheat temperature is low. Press reset and check whether the alarm recurs. If the fault recurs, contact your installer.
[E052] Phase 1 missing [E053] Phase 2 missing [E054] Phase 3 missing	This message appears in the event of a phase failure.

Alarm messages	Description
[E055] Incorrect phase sequence	The product's compressor motor must rotate in the right direction. The product checks that the phases are connected correctly; otherwise, an alarm is triggered. This will require changing two of the phases into the product. The power supply to the system must be shut off when rectifying this fault. This fault generally only occurs during installation.
[E057] Motor protect high curr.	High current into the compressor has been detected. Press reset and check whether the alarm recurs. If the fault recurs, contact your installer.
[E058] Motor protect low curr.	Low current into the compressor has been detected. Press reset and check whether the alarm recurs. If the fault recurs, contact your installer.
[E061] Max thermostat	This alarm message appears if the product becomes too hot. During installation, make sure the max. thermostat (F10) has not been triggered as there is a chance of this occurring if the boiler has been stored in extremely cold temperatures, Reset it by pressing in the button on the electrical switchboard behind the front panel.
[E027] Comm. error HP	This message is displayed when the display card (A1) cannot communicate with the HP control card (A5).
[E063] Comm. err. relay board	This message is displayed when the display card (A1) cannot communicate with the relay card (A2).
[E021] Comm. err. motor protection	This message is displayed when the HP control card (A5) cannot communicate with the motor protection (A4).
[E086] Comm. err. expansion card	This message is displayed when the display card (A1) cannot communicate with CTC Solar control/Expansion card (A3).
[Exxx] 'sensor'	An alarm message is displayed if an error occurs with a sensor that is not connected or has short-circuited and if the value is outside the sensor's range. If this sensor is important to the system's operation, the compressor stops. This requires the alarm to be reset manually after the fault has been rectified. For the following sensors, the alarm is reset automatically after correction: : [E003] Sensor brine in [E005] Sensor brine out [E028] Sensor VP in [E029] Sensor VP out [E030] Sensor outdoor (B15) [E031] Sensor primary flow 1 (B1) [E032] Sensor primary flow 2 (B2) [E036] Sensor high pressure [E037] Sensor discharge [E043] Sensor low pressure [E074] Sensor Room 1 (B11) [E075] Sensor Room 2 (B12) [E080] Sensor suction gas [E137] Sensor Diff thermostat (B46) [E138] Sensor EcoTank lower (B42) [E139] Sensor EcoTank upper (B41)
[E057] Motor protect high curr.	High current into the compressor has been detected. Press reset and check whether the alarm recurs. If the fault recurs, contact your installer.
[E058] Motor protect low curr.	Low current into the compressor has been detected. Press reset and check whether the alarm recurs. If the fault recurs, contact your installer.
[E087] Driver	Driver fault.
[E088] Driver: 1 - [E109] Driver: 29	Press reset and check whether the alarm recurs. If the fault recurs, contact your installer and tell them the error code number where applicable.
[E117] Driver: Offline	Communication error. Heat pump and driver not communicating.

Alarm messages	Description
[E135] Risk of freezing	Alarm indicating that the temperature of the outgoing water from the heat pump (HP out) is too low for defrosting. The water volume in the system may be too low. The flow may be too low. (Applies to EcoAir)
[E152] 4-way valve	This alarm message is displayed if a fault occurs with EcoAir's 4-way valve or if the connection pipes to the EcoAir are incorrectly connected. Press reset and check whether the alarm recurs. If the alarm recurs, check that the charge pump is pumping water to the heat pump's lower connection. If the fault recurs, contact your installer.
[E163] Defrost max time duration	The heat pump has not had time to complete defrosting within the maximum time. Make sure that any ice on the evaporator has disappeared.

12. Pipe installation

The installation must be carried out in accordance with current standards and regulations. Refer to BBR-99 and the Warm and Hot Water Instructions 1993. The product must be connected to an expansion vessel in an open or closed system. Do not forget to flush the heating circuit clean before connecting. Apply all the installation settings based on the description in the chapter on "First start".

The heat pump operates with a max primary flow/return temperature across the condenser of up to 65/58°C going towards the lower tank.

When the heat pump operates going towards the upper tank, the primary flow can reach up to 70 °C from the condenser.

12.1 Filling

Filling valve (no. 90, see schematic diagram on next page) is connected to the radiator return pipe. Alternatively, the valve can be installed in the direction of the expansion pipe. When filling the system, the mixing valve (Y1) must be wide open. Pull out the knob on the valve and turn it anticlockwise as far as you can. Do not forget to push in the valve's knob in automated mode.

12.2 Schematic diagram

This shows the main connection between the heat pump and the property's heating circuit and DHW system. Different installations and systems may look different, e.g. a one or two-pipe system, which means that the finished installation may be different. To find out about connecting the cold side, see the section entitled "Connecting the brine system".

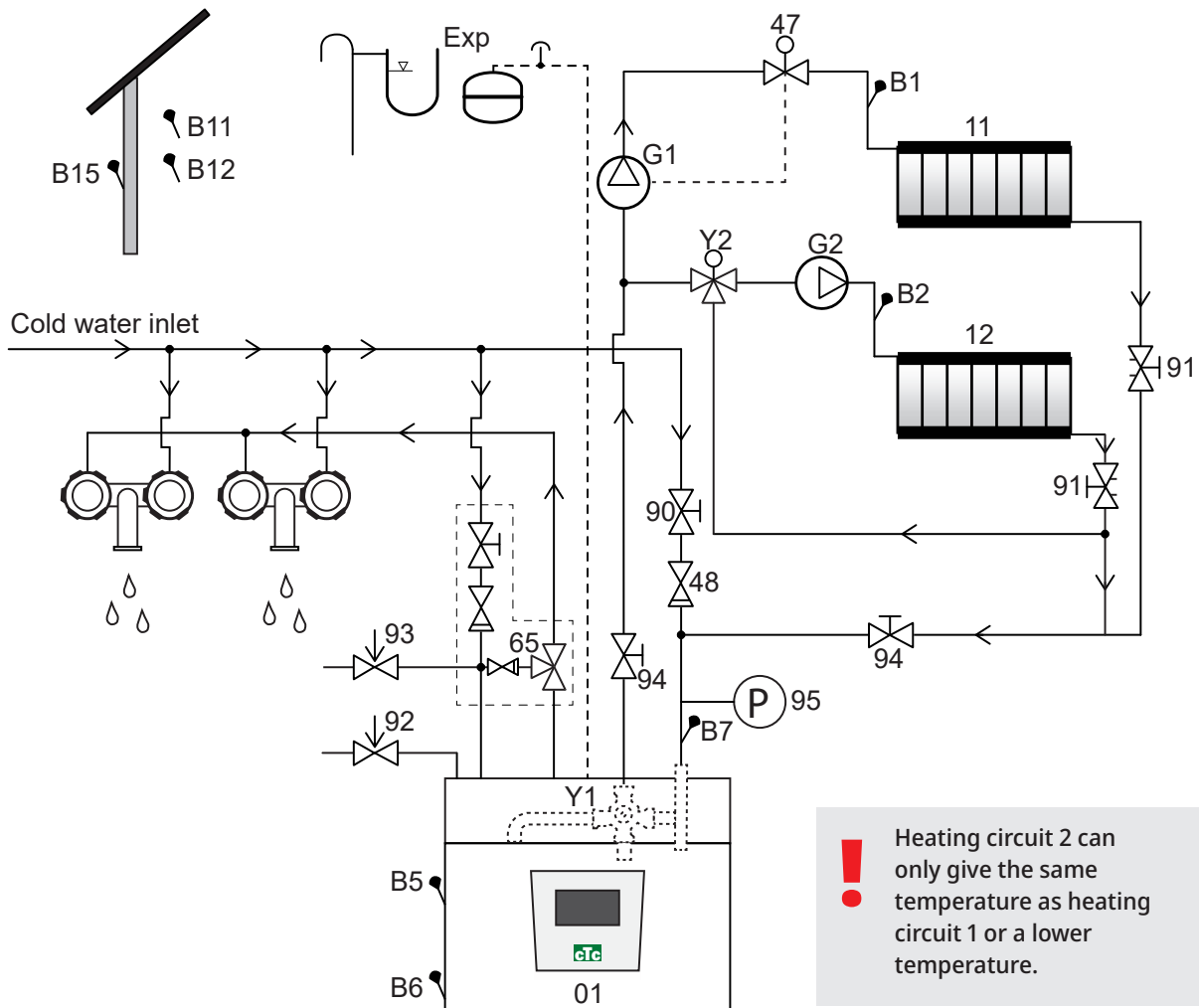

01	CTC EcoHeat 400	Y2	Mixing value, heating circuit 2
B1	Primary flow sensor, heating circuit 1	11	Heating circuit 1
B2	Primary flow sensor, heating circuit 2	12	Heating circuit 2
B5	Sensor upper tank	47	Electric shut-off valve, heating circuit
B6	Sensor lower tank	48	Non-return valve for incoming cold water
B7	Sensor, radiator return	65	Mixing valve for DHW
B11	Room sensor 1	90	Filling valve, heating circuit
B12	Room sensor 2	91	Adjustment valves for heating coils
B15	Outdoor sensor	92	Boiler safety valve (factory-installed), 2.5 bar
G1	Circulation pump, heating circuit 1	93	Safety valve for DHW
G2	Circulation pump, heating circuit 2	94	Shut-off valve
Y1	Mixing valve, bivalent heating circuit	95	System/boiler pressure installed on return pipe

Circulation pump, heating circuit (G1) (G2)

The circulation pump is fitted on the boiler's primary flow and must be connected electrically from the boiler, see chapter on Electrical installation.

Mixing valve DHW (65)

Install a mixing valve for the hot tap water in order to avoid the risk of scalding.

Safety valve for DHW out temp (93)

Fit the enclosed valve to the incoming cold water connection. Connect the waste pipe to the waste system directly to the floor drain or, if the distance is more than two metres, to a funnel. The waste pipe must slope towards the waste system, be installed frost-free and left open to the atmosphere/without pressure.

Non-return valve (48)

Fit the non-return valve to the incoming cold water connection.

Shut-off valve (94)

It is important to fit a shut-off valve (94) to both the primary flow and return flow.

Boiler safety valve (92)

The boiler's safety valve (2.5 bar) is fitted in the factory on the left side of the top. Connect the waste pipe to the waste system directly to the floor drain or, if the distance is more than two metres, to a funnel. The waste pipe must slope towards the waste system, be installed frost-free and left open to the atmosphere/without pressure.

Filling valve, heating circuit (90)

Fit a filling valve between the cold water connection and the radiator return pipe, or between the cold water pipe and the expansion pipe.

Manometer system pressure (95)

Fit the manometer on the expansion pipe or radiator return pipe.



NB: The waste pipe must be fitted to the waste system.



NB: It is important to fit Shut-off Valve (94) to both the primary flow and return flow.

Expansion vessel connection

The EcoHeat must be connected to a closed expansion vessel. The heat pump is ready to be fitted to an 18 l closed expansion vessel, positioned compactly on top of the product. The expansion vessel with the required angle connection is available as an accessory. Then connect the system manometer to the radiator return pipe.

An extra pressure gauge can be added. If you use an open system, the distance between the expansion vessel and the highest placed radiator must not be below 2.5 m in order to avoid introducing oxygen into the system.

Note that no hot water circulation must be connected as it affects the function of the heat pump and the system. If the heat pump is connected with another heat source, e.g. an existing boiler, the installations must have separate expansion vessels.

Top view

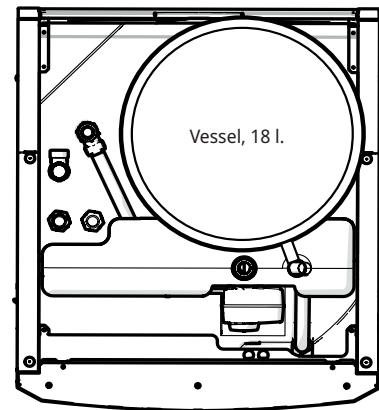

The pre-pressure in the expansion tank is calculated according to the height (H) between the highest-positioned radiator and the expansion tank. The pre-pressure must be checked/set before the system is filled with water. The system pressure must be set 0.3 bar higher than the pre-pressure in the expansion tank. For example, a pre-pressure of 1.0 bar (5 mvp) means a maximum permitted height difference of 10 m.

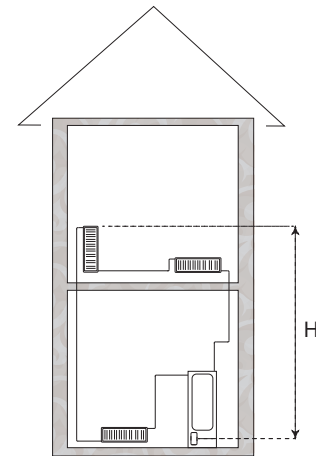

Maximum height (H) (m)	Pre-pressure (bar)	Maximum volume in the heating circuit (excluding product) (L)
5	0.5	310
10	1.0	219
15	1.5	129

- ! The expansion tank provided is pre-pressurised to approx. 1 bar, and therefore needs to be adjusted to a suitable pre-pressure for the building. This must be done before the system is filled with water.
- If an open expansion tank is used, the distance between the expansion tank and the highest placed radiator must not be below 2.5 m, in order to avoid introducing oxygen into the system.
- If a heat pump is connected with another heat source, e.g. an existing boiler, the installations must have separate expansion vessels.

Operation without a brine system

EcoHeat can be used without the brine system's cold side being connected. The heat pump then operates like a normal electric boiler with its control system providing full functionality. However, the DHW capacity is slightly lower as only the upper part of the tank is heated. Make sure that the compressor is blocked.

Water taps

In some cases, unusual noises may be produced by the house's pipe system and EcoHeat due to the jolts which occur when the flow is quickly interrupted. There is no fault with the product, but the noise may occur when older types of instant closing mixers are used. More recent types are often fitted with a soft-closing mechanism. Alternatively, a shock arrestor can be fitted. Keeping the jolting to a minimum also helps avoid unnecessary wear and tear affecting the DHW system.

DHW system

You can connect a DHW circulation system. You can see this kind of connection in the figure below.

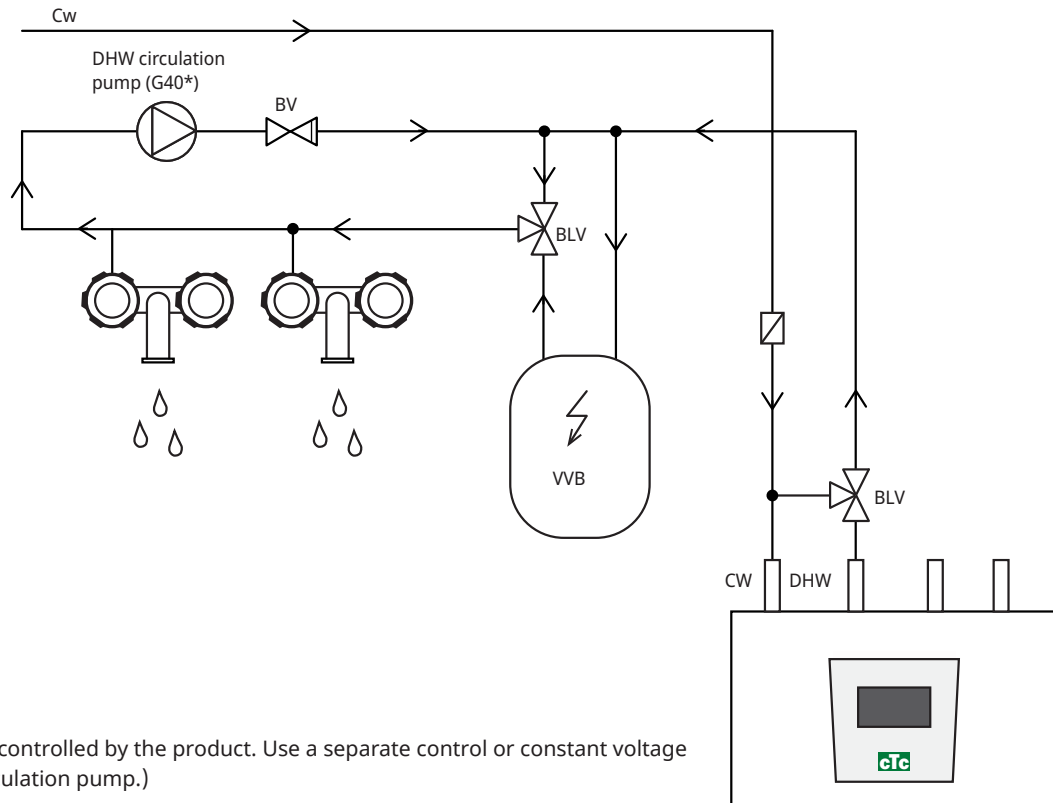

(*G40 not controlled by the product. Use a separate control or constant voltage for the circulation pump.)

Pressure drop

Pressure drop in mixing valve

The diagram below shows a drop in pressure in the mixing valve.

Start with the heat requirement in kW (e.g. 15 kW) and move vertically to the selected Δt (e.g. 10 °C). Then move horizontally to the line for the EcoHeat mixing valve = line 6.3 DN20. The reading for the pressure drop is taken from the scale directly below (4 kPa).

For EcoHeat, see valve DN20.

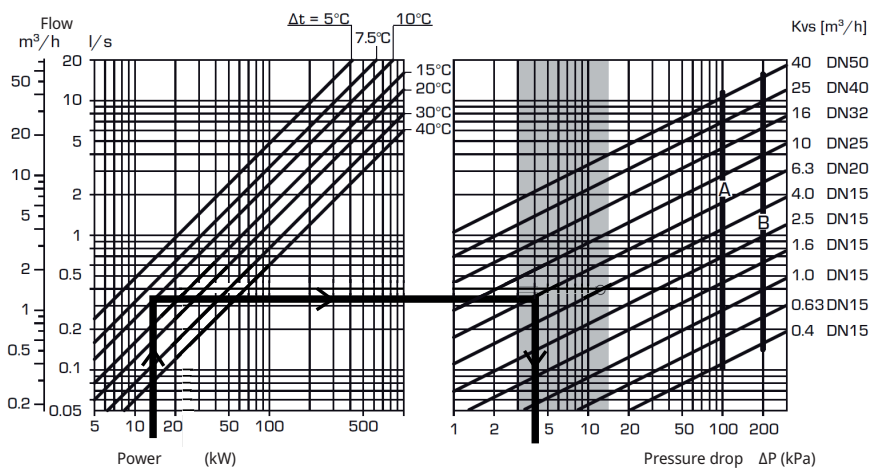

12.3 Heat medium pump (G11)

CTC EcoHeat 406-408

25/7-130 PWM

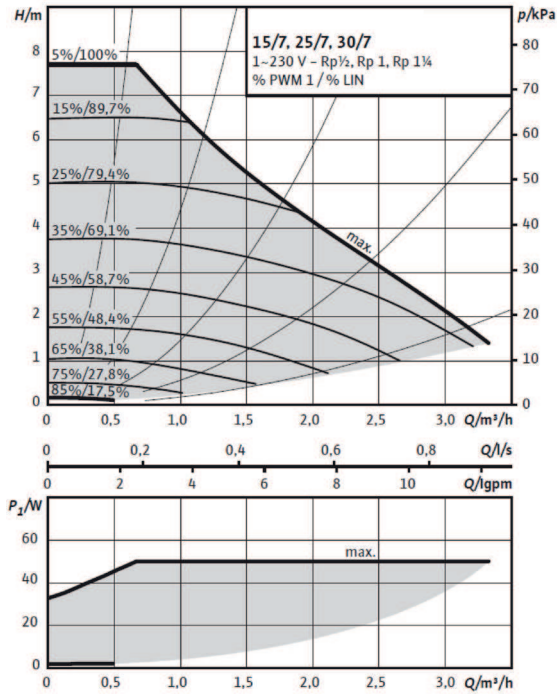

CTC EcoHeat 410-412

25/8-130 PWM

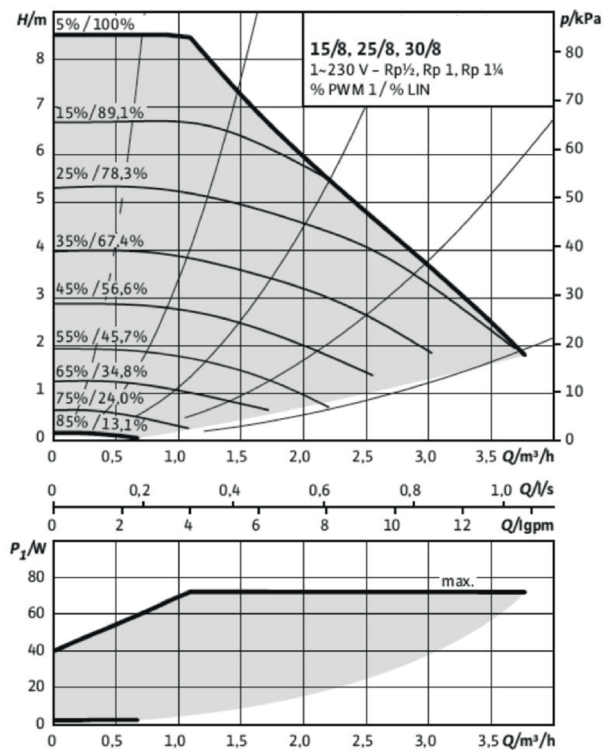

12.4 Schematic diagram of passive cooling – Combined cooling/heating

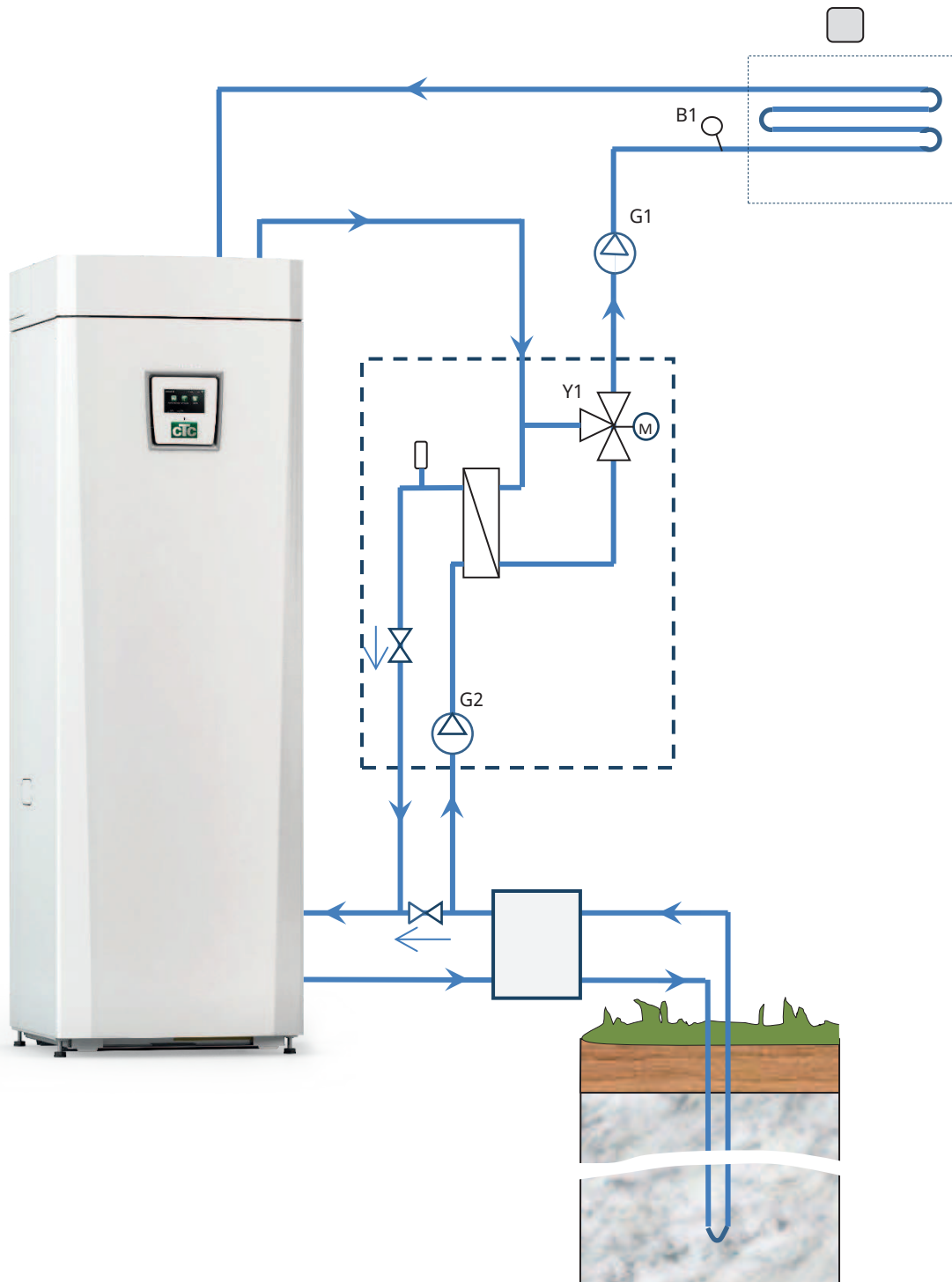

12.5 Schematic diagram of passive cooling in separate heating circuits

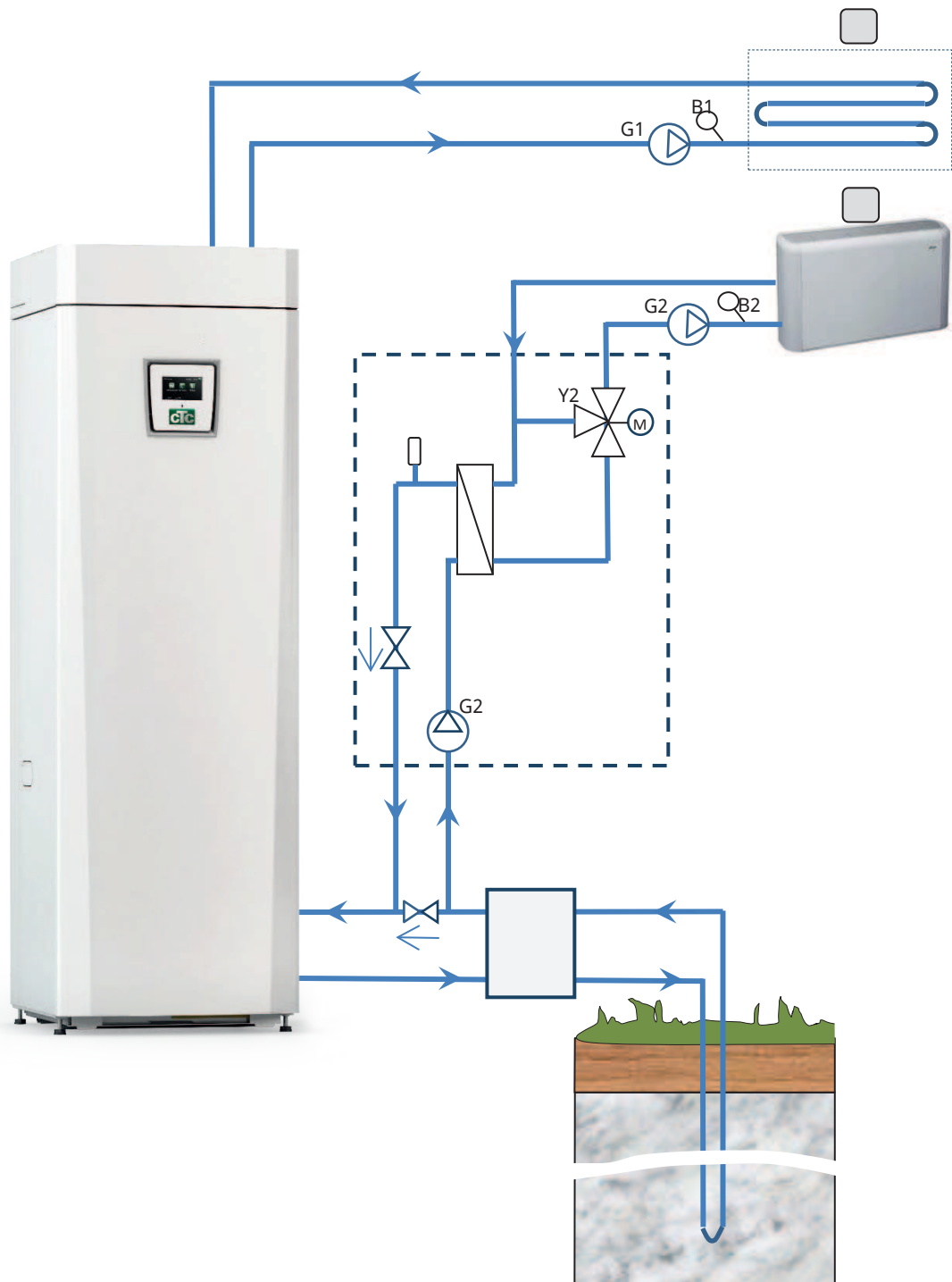

12.5.1 Diff thermostat function

The diff thermostat function is used to transfer heat from the tank with sensor (B46) to the H-tank.

The function compares temperatures in the tanks and when it is warmer in the tank (B46), charging to the H-tank is started.

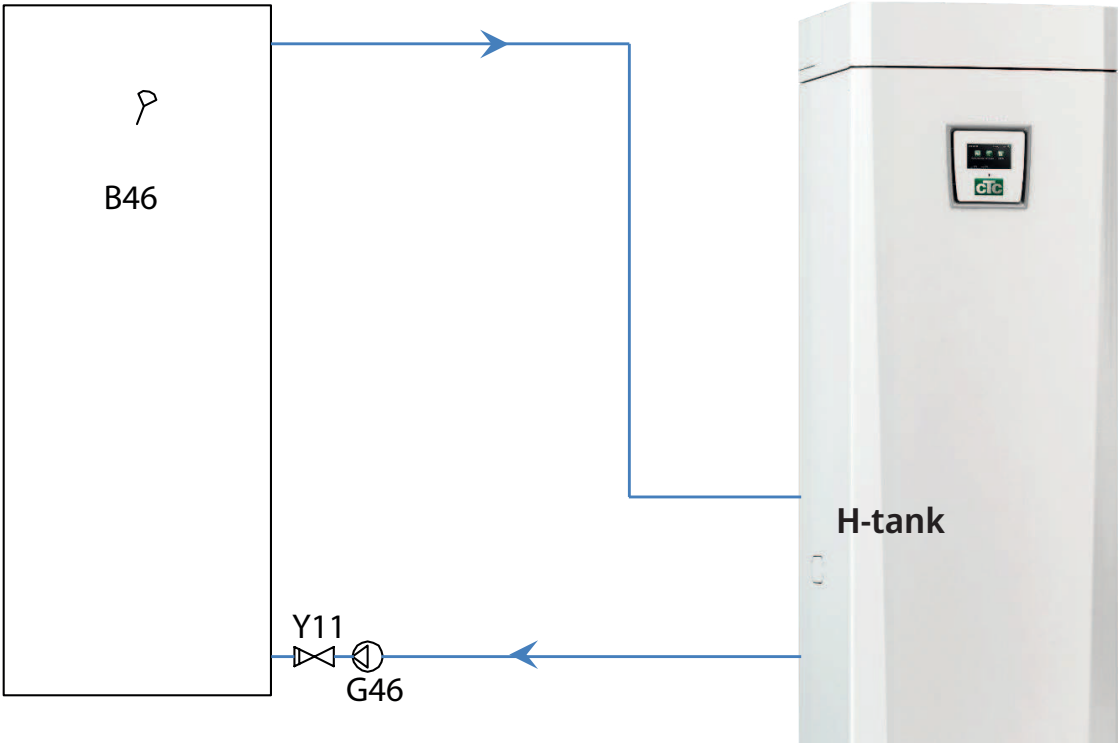

13. Connecting the brine system

The brine system, i.e. the ground collector loop, must be assembled and connected by a qualified tradesman in accordance with current regulations and design guidelines.

Extreme care must be taken to ensure that no dirt gets on the collector hoses, which must be washed clean before being connected. The protective caps must always remain in place while work is in progress.

The temperature of the brine system can fall below 0 °C. It is therefore important that no water-based lubricants and similar are used during installation. It is also important that all the components are insulated against condensation to prevent the build-up of ice.

Connections

The brine system may be connected to the right, left or back of the heat pump. Cut away the cover plate on the side where the brine system is to be connected. The insulation on the inside of the cover plate has been grooved to enable an opening to be cut for the brine hoses provided. When the opening has been made through both the insulation and cover plate, carry out the installation as follows:

1. In order to protect the brine hoses, fasten the protective edging provided around the edge of the opening in the insulation plate. Adjust the length of the protective edging to suit the opening as required.
2. Attach the provided compression couplers to the cooling module connector pipes. To facilitate attachment, the upper brine pump connection may be loosened and rotated if necessary.
3. Pass the brine hoses through the opening in the side cover plates and connect them to the compression couplers. Ensure that the connections are well insulated to avoid the build-up of ice and condensation.
4. Install the collector system after this according to the schematic diagram.

You can also connect the primary flow on one side and the return on the other. See the section entitled "Measurement details for measurements and dimensions". The pipe between the heat pump and collector loop should have an internal diameter of no less than Ø28 mm.

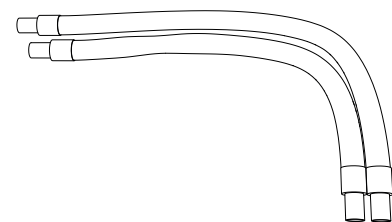
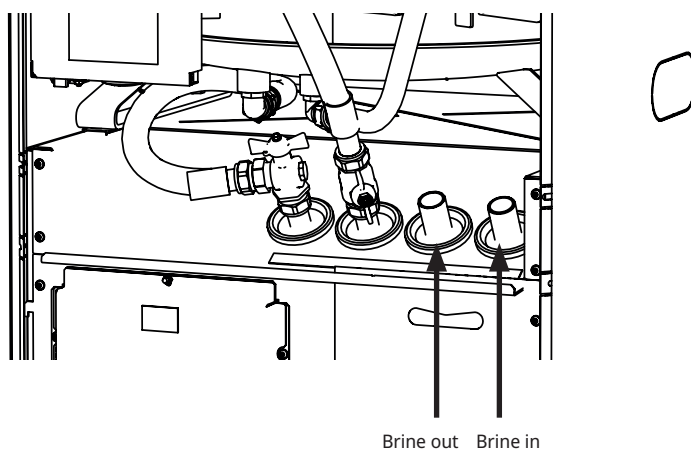
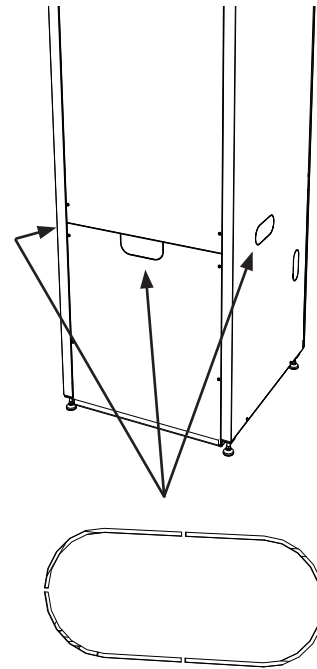

Arrange the hoses so that the longest is the outermost. This applies whether connected from the left or right.

Valves

You fit the valves as shown in the schematic diagram on the next page. To facilitate servicing of the cooling unit, shut-off valves must be fitted to both the incoming and outgoing connections. Fit bifurcated valves so that it is possible to fill and bleed the collector circuit later.

Bleeding

The collector circuit must not contain any air. Even the smallest amount of air can jeopardise the heat pump's operation. See the section Refilling and venting below.

Insulation against condensation

You must insulate all the pipes in the brine system against condensation. Otherwise, there will be a strong build-up of ice and condensation.

Filling and venting

Mix water and antifreeze solution in an open vessel. Connect hoses to the shut-off valves (98a and 98b) as shown in the figure. NB: The hoses must have a minimum diameter of 3/4". Connect a powerful external pump (101) for refilling and bleeding. Then reset the three-way valve (100) and open the valves (98a and 98b) so that the brine passes through the mixing container (102). Also make sure that the valve (98d) is open.

If the heat pump is connected to the power supply, start the brine pump (103) as follows:

- Open the "Installer/Service/ Function Test" menu.
- Select the "Brine Pump" option and activate it. The brine pump runs until it is manually stopped.

Allow the brine to circulate in the system for a long period of time until it is completely free of air. There could still be air in the system, even though no air accompanies the liquid out. Reset the 3-way valve (100) so that any remaining air can come out.

Bleed the level vessel (96) by loosening the plug on the top of the level vessel. Now close the valve (98a) while the filling pump continues to run. The filling pump (101) now pressurises the system. Also close the valve (98b) and shut off the filling pump.

If the level in the level vessel is too low, close the valves (98c) and (98d).

Unscrew the plug and fill the vessel to around 2/3 full. Screw the plug back in and open the valves (98c) and (98d).

Pressure/level switch

In some cases, extra protection is required due to local requirements or provisions. For example, the requirement in some areas is for the system to be installed within a water catchment area. The pressure/level switch connects to terminal blocks K22/K23/K24/K25 and is then defined in the "Installer/Define/Def. Heat Pump" menu. If there is a leak, the compressor and brine pump stop and the Flow/level switch alarm appears on the display.



Use the "Brine pump On" for 10 days to bleed the system properly.

13.1 Brine system schematic diagram

- 96 Level/expansion vessel
- 97 Filler manifold
- 98 Shut-off valve
- 99 Filter
- 100 3-way valve
- 101 External filling pump
- 102 Mixing vessel
- 103 Brine pump
- 104 Evaporator
- 105 Safety valve 3 bar

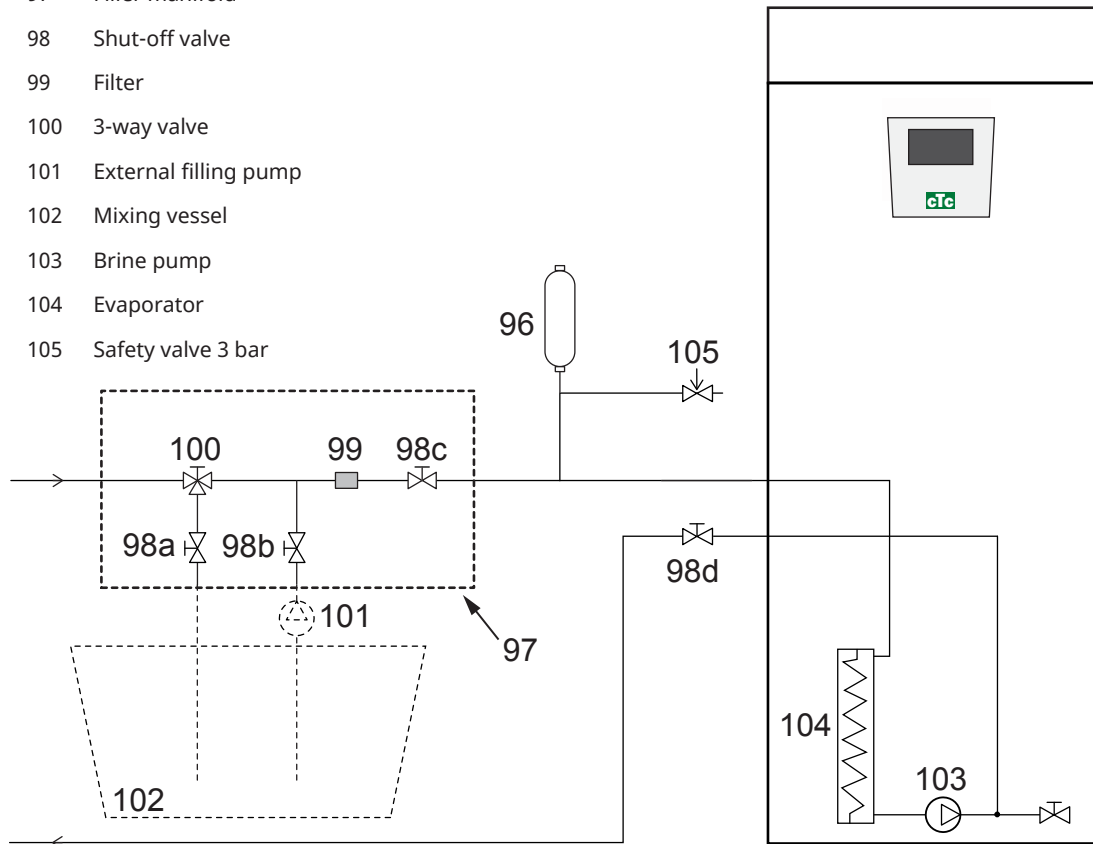

The diagram shows the main connection for the brine system. The filling equipment is represented by the parts displayed with dashes. NB: Collector hoses must have a bleeding facility as air pockets can occur. Always check the filter (99) when filling and bleeding the brine system.

Post-installation check on brine system

After a few days, you must check the fluid level in the vessel. Fill if necessary and close the valves (98c and 98d) when filling.

Level vessel/Expansion vessel

The level vessel should be fitted to the incoming line from the borehole or ground loop, at the system's highest point. Bear in mind that the tank can produce condensate on its exterior. Fit the safety valve (105) as shown in the schematic diagram and fit a suitable plug to the top of the vessel.

If the vessel cannot be fitted at the highest point, a closed expansion vessel can be fitted.

Filler manifold with dirt filter

A filler manifold for topping up, adding and filtering brine. Arrows on the valve housing indicate the flow direction. Close valves (98c and 100) when cleaning the filter. Unscrew the filter cap and flush the filter clean. When refitting, the pin under the filter holder should be fed into the designated hole in the filter housing. Top up with a little brine, if necessary, before fitting the cap. The filter should be checked and cleaned after a short period of operation.

! The mixing vessel and pump must be of a good size.

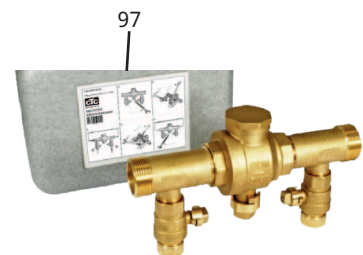

Brine

The brine circulates in a closed system. The fluid consists of water and antifreeze solution. Sentinel R500 & R500C are recommended for use in the brine circuit. The glycol is mixed at a concentration of slightly less than 30%, which is equivalent to fire risk class 2b and a freezing point of around -15°C .

It is a CTC recommendation that around 1 litre of brine/glycol is required per metre of collector hose, i.e. around 0.3 litres of antifreeze solution will be needed per metre of hose, for a hose diameter of 40 mm.

Air pockets

To avoid air pockets, make sure that the collector hoses constantly rise towards the heat pump. If this is not possible, it must be possible to bleed the system at the high points. The filling pump usually manages smaller local height discrepancies.

Checking brine difference

When the heat pump is running, regularly check that the temperature difference between incoming and outgoing brine temperatures is not too large. If there is a large difference, one of the causes may be due to air in the system or a blocked filter. If this is the case, the heat pump triggers the alarm.

The alarm factory setting is 7°C , but 9°C is permitted for the first 72 hours while the compressor is running, as microbubbles in the system can reduce brine flow.



Check the dirt filter after bleeding has been completed.



The fluid must be thoroughly mixed before the heat pump is started.

13.2 Brine pump

The circulation pumps in CTCs products are of the energy efficiency class A.

- CTC EcoHeat 406-408 has pump 25-70 180.
- CTC EcoHeat 410-412/EcoPart 410-417 & CTC GSi 12 has pump 25-125 180.

25/70-180, 1x230V, 50/60Hz

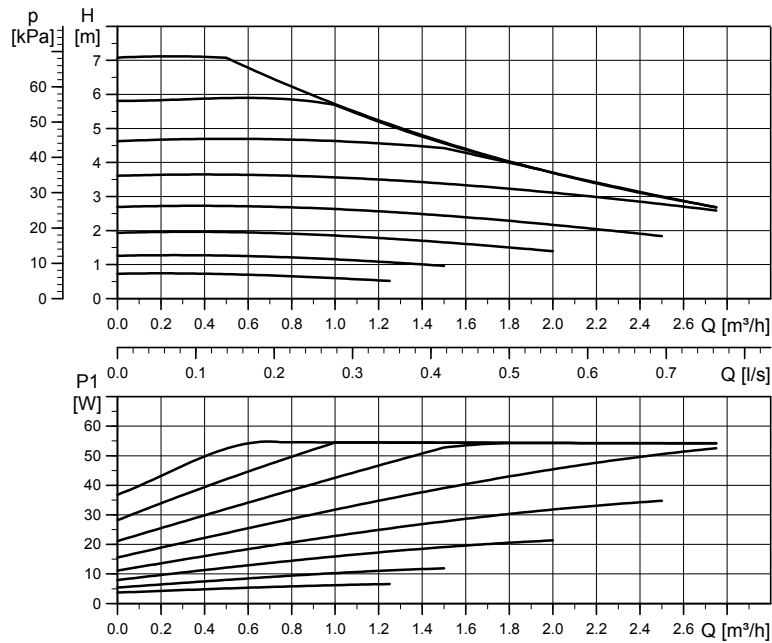

25/125-180 PWM, 1x230V, 50/60Hz

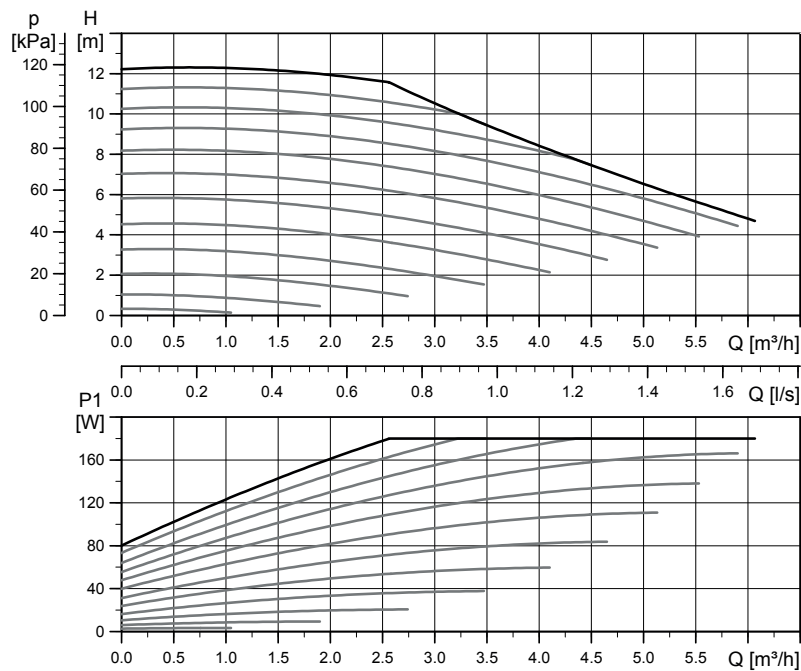

14. Electrical installation

Installation and heat pump connection must be performed by an authorised electrician. All wiring must be installed according to applicable provisions. The product is internally connected by the factory and set for a 5.5 kW power output. It has equal phase loading at all power steps.

Supply

The power supply cable is connected at (1), length 180 cm. The minimum group fuse size is specified in "Technical Data".

Omnipolar safety switch

The installation should be preceded by an omnipolar safety switch according to overvoltage category III, which ensures disconnection from all electric power sources.

Connecting the circulation pump, heating circuit (G1)

The radiator pump is connected electrically to the terminal board. Electrical data: 230 V 1N~. Internal fuse 10 A.

Max thermostat

If the heat pump has been stored in an extremely cold place, the max thermostat may have been triggered. Reset it by pressing in the button on the electrical switchboard behind the front panel.

Always check on installation that the max thermostat has not tripped.

Extra low voltage protection

The following outputs and inputs have extra low voltage protection: current transformer, outdoor sensor, room sensor, primary flow sensor, return sensor, NR/SO.

Connection of outdoor sensor (B15)

The sensor should be set up on the house's northwest or north side, so that it is not exposed to morning and evening sun. If there is a risk of the sensor being affected by the sun's rays, it must be protected by a screen.

Place the sensor at around 2/3 of the height of the facade near a corner, but not under a roof projection or other form of wind protection. Do not place it either above ventilation ducts, doors or windows where the sensor may be affected by factors other than the actual outdoor temperature.

Connecting the room sensor (B11) (B12)

The room sensor is fitted at a central point in the house, in the most open position possible, ideally in a hall between several rooms. This is the best position for the sensor to record an average temperature for the house.

Feed a three-conductor cable (minimum 0.5 mm²) between the heat pump and room sensor. Then attach the room sensor securely in a position roughly two thirds of the way up the wall. Connect the cable to the room sensor and heat pump.

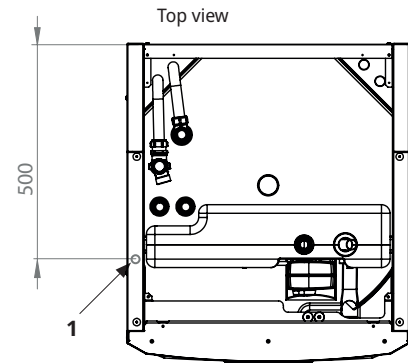

Symbol for max thermostat

! Do not attach the sensor cable permanently until you have tested where the best location is.

Connecting the primary flow/return sensor

fit the primary flow sensor to the primary flow pipe, ideally after the circulation pump. Fit the return sensor to the return pipe.

The sensing part is towards the end of the sensor (see sketch).

- Attach the sensor using the cable tie provided.
- Ensure that the sensor makes good contact with the pipe. Apply contact paste to the front part of the sensor between the sensor and the pipe if good contact is otherwise difficult to obtain.
- **Important!** Insulate the sensor using pipe insulation.

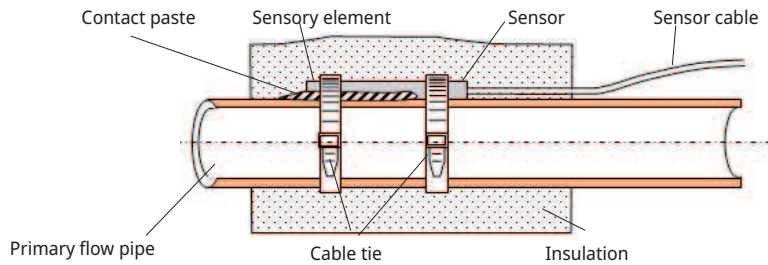

Current sensor connection

The three current sensors, one for each phase, are fitted on the fuse panel in the following manner:

Each phase from the electricity distribution board supplying the product is channelled through a current sensor before termination at the relevant terminal. This allows the phase current to be sensed all the time and compared with the value set for the heat pump's load switch. If the current is higher, the control unit drops to a lower heat output on the electric heater. If this is insufficient, the heat pump is also limited. When the power drops back below the set value, the heat pump and electric heater are reconnected.

This means that the current sensors, along with the electronics, prevent more power being supplied than the main fuses can tolerate.

The current sensors' cable holes are 11 mm in diameter.

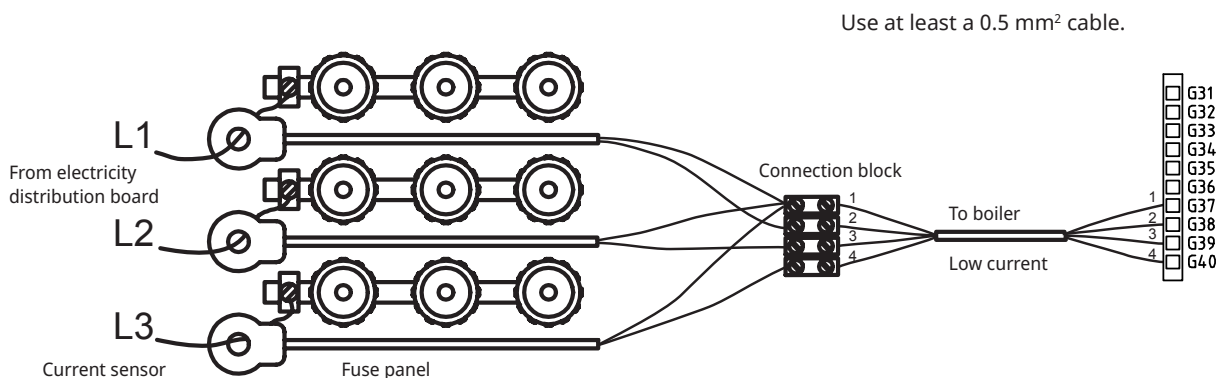

14.1 Positioning of electrical components

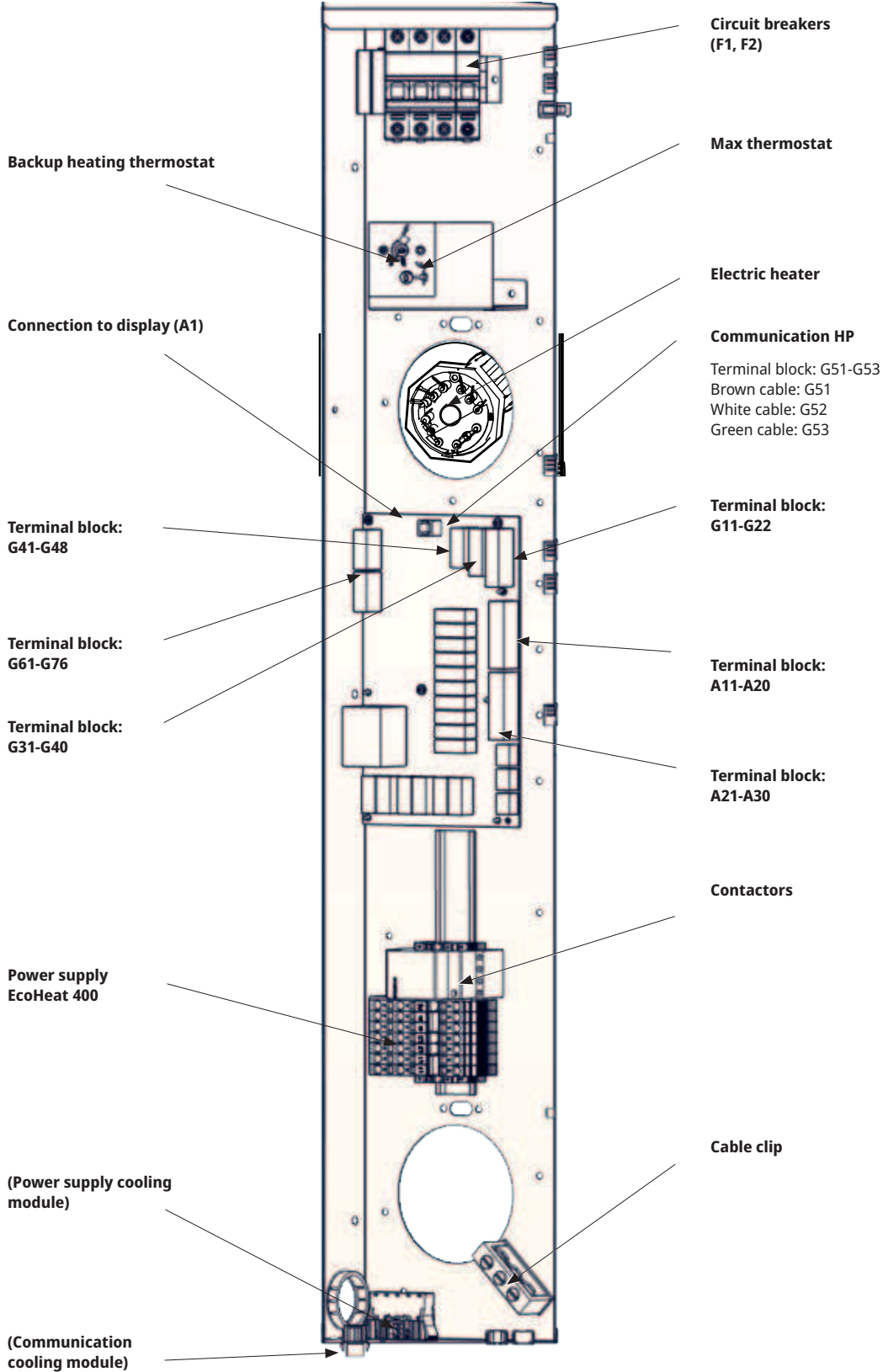

Terminal board

There is a terminal board for sensors etc. behind the panel.

- ❗ Open the spring block first using a screwdriver before the cable is inserted.
- Otherwise, there is a risk of poor contact. Also make sure that the conductor is sufficiently stripped.

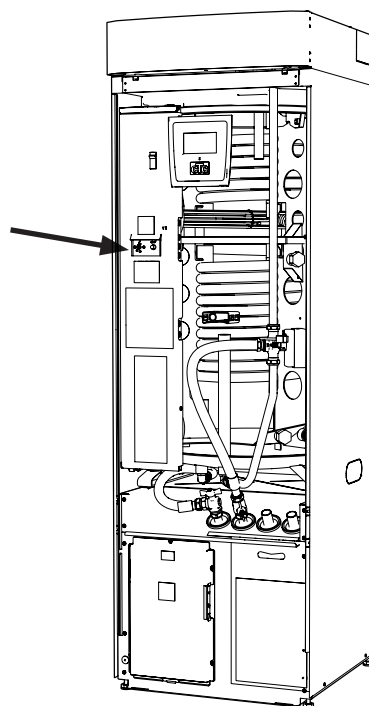
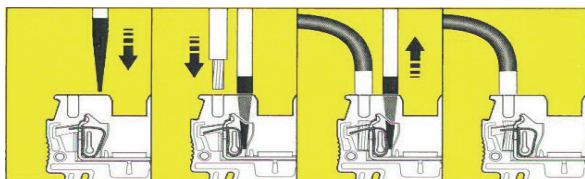

14.2 Settings to be carried out by the installation electrician

The following settings shall be made by the installation electrician after installation:

- Select main fuse size.
- Select the power limitation for the electric heater.
- Check room sensor connection.
- Check that the sensors connected indicate reasonable values.

Carry out the checks below.

Main fuse and effect limitation settings

See the chapter on "First start".

Check room sensor connection

- Go to the menu: "Installer/Service/Function test/Heating system".
- Go down and select the option LED room sensor and press OK.
- Select On using the + button and press OK. Check that the room sensor LED lights up. If not, check the cables and connection.
- Select Off using the - button and press OK. If the OK LED goes off, the check is complete.
- Return to start menu by pressing the Home button.

Checking connected sensors

If any sensor is incorrectly connected, a message will appear on the display, e.g. "Alarm sensor outside". If several sensors are incorrectly connected, the different alarms are displayed on different rows.

If no alarm is displayed, the sensors are connected correctly.

The current sensor connection has no alarm, but the current value can be read in the Operation data menu. Note that the tolerance/accuracy is very low with small current values.

14.3 Installing a backup power supply

The DIP switch on the relay card (A2) is used to set the backup power supply. The DIP switch is marked "RESERV" (BACKUP).

When the switch is set to ON, the step is actively operating in backup heating mode.

3x400V

Relay	EL3A	EL2B	EL2A	EL1B	EL1A
Current	10 A	10 A	2.6 A	10 A	1.3 A
Output	1.2 kW	2.3 kW	0.6 kW	2.3 kW	0.3 kW.

1x230V

Relay	-	EL2B	EL2A	EL1B	EL1A
Current	-	8.7 A	8.7 A	8.7 A	13 A
Output	-	2.0 kW	2.0 kW	2.0 kW	3.0 kW

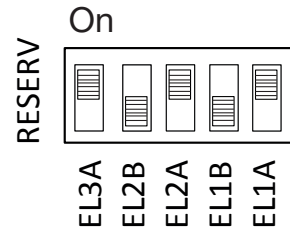

Example for 1.2 + 0.6 + 0.3 = 2.1 kW 3~.

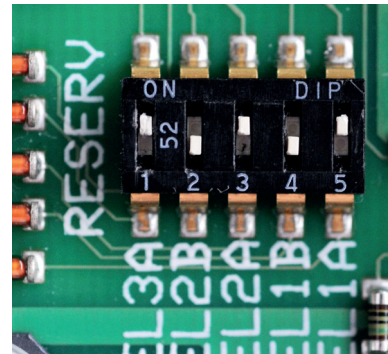

14.4 Groundwater heating

Groundwater can also be used as a heat source for CTC's heat pumps. The groundwater is pumped up to an intermediate heat exchanger that transfers the energy to the brine liquid. It is important that an intermediate heat exchanger is installed in the system. The intermediate heat exchanger prevents the product's evaporator from becoming damaged due to deposits from groundwater particles and minerals, which could otherwise involve expensive work on the product's refrigerant system. Water requirements analysis should always be undertaken for intermediary heat exchangers. Local regulations and permit requirements must be considered. The return water is discharged elsewhere, to a drilled return flow well or similar.

Also pay attention to the intermediary heat exchanger supplier's instructions.

The brine pump (G20) and groundwater pump (G21) must be connected to run simultaneously in order to avoid the risk of freezing. For connection information, see the wiring diagram.

14.5 Connection of pump (G46) to Differential thermostat function

230V 1N~

The circulation pump (G46) is connected at the following terminal blocks: Relay card in EcoHeat 400 (see wiring diagram).

Note the cable colours!

Phase:	brown	Terminal A12
Neutral:	blue	
Earth:	yellow/green	

Check the function by test running the pump in the "Installer/Service/Function Test" menu in the control system.

14.6 Connection of sensor (B46) to Differential thermostat function

Ntc22k

Sensor B46 is connected to terminal block G65,G66.

14.7 Resistances for sensors

Sensor Type 1 NTC Resistance kΩ		Sensor Type 2 NTC Resistance kΩ		Sensor Type 3 NTC Resistance kΩ		NTC 50 Resistance kΩ	
Temperature °C	Resistance kΩ	Temperature °C	Resistance kΩ	Temperature °C	Resistance kΩ	Temperature °C	Resistance kΩ
100	0.22	100	0.67	130	5.37	150	0.89
95	0.25	95	0.78	125	6.18	145	1.00
90	0.28	90	0.908	120	7.13	140	1.14
85	0.32	85	1.06	115	8.26	135	1.29
80	0.37	80	1.25	110	9.59	130	1.47
75	0.42	75	1.47	105	11.17	125	1.67
70	0.49	70	1.74	100	13.06	120	1.91
65	0.57	65	2.07	95	15.33	115	2.19
60	0.7	60	2.5	90	18.1	110	2.5
55	0.8	55	3.0	85	21.4	105	2.9
50	0.9	50	3.6	80	25.4	100	3.4
45	1.1	45	4.4	75	30.3	95	3.9
40	1.3	40	5.3	70	36.3	90	4.6
35	1.5	35	6.5	65	43.6	85	5.4
30	1.8	30	8.1	60	52.8	80	6.3
25	2.2	25	10	55	64.1	75	7.4
20	2.6	20	12.5	50	78.3	70	8.8
15	3.2	15	15.8	45	96.1	65	10.4
10	4	10	20	40	119	60	12.5
5	5	5	26	35	147	55	15
0	6	0	33	30	184	50	18
-5	7	-5	43	25	232	45	22
-10	9	-10	56	20	293	40	27
-15	12	-15	74	15	373	35	33
-20	15	-20	99	10	479	30	40
-25	19	-25	134	5	619	25	50
-30	25	-30	183			20	62
						15	78
						10	99
						5	126

Outdoor sensor NTC 150

Temperature °C	Outdoor sensor Resistance Ω
70	32
65	37
60	43
55	51
50	60
45	72
40	85
35	102
30	123
25	150
20	182
15	224
10	276
5	342
0	428
-5	538
-10	681
-15	868
-20	1115
-25	1443
-30	1883
-35	2478
-40	3289

NTC 22 kΩ

Temperature °C	NTC 22 k Resistance Ω
130	800
125	906
120	1027
115	1167
110	1330
105	1522
100	1746
95	2010
90	2320
85	2690
80	3130
75	3650
70	4280
65	5045
60	5960
55	7080
50	8450
45	10130
40	12200
35	14770
30	18000
25	22000
20	27100
15	33540
10	41800
5	52400
0	66200

Suction gas sensor

Temperature °C	NTC 015 Resistance Ω
40	5830
35	6940
30	8310
25	10000
20	12090
15	14690
10	17960
5	22050
0	27280
-5	33900
-10	42470
-15	53410
-20	67770
-25	86430

14.8 Wiring diagram tank 400V 3N~

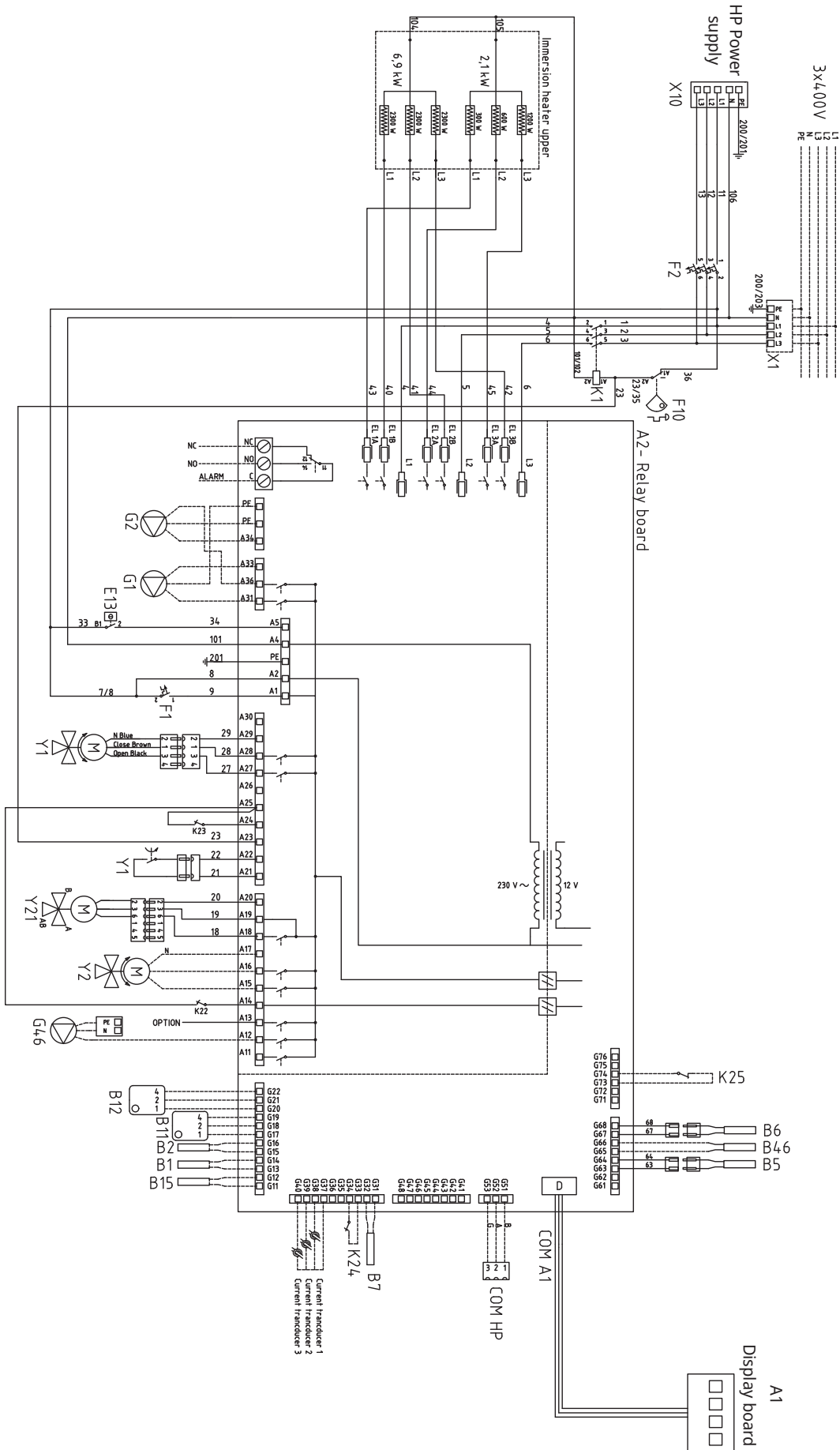

586618

14.9 Wiring diagram tank 230V 1N~

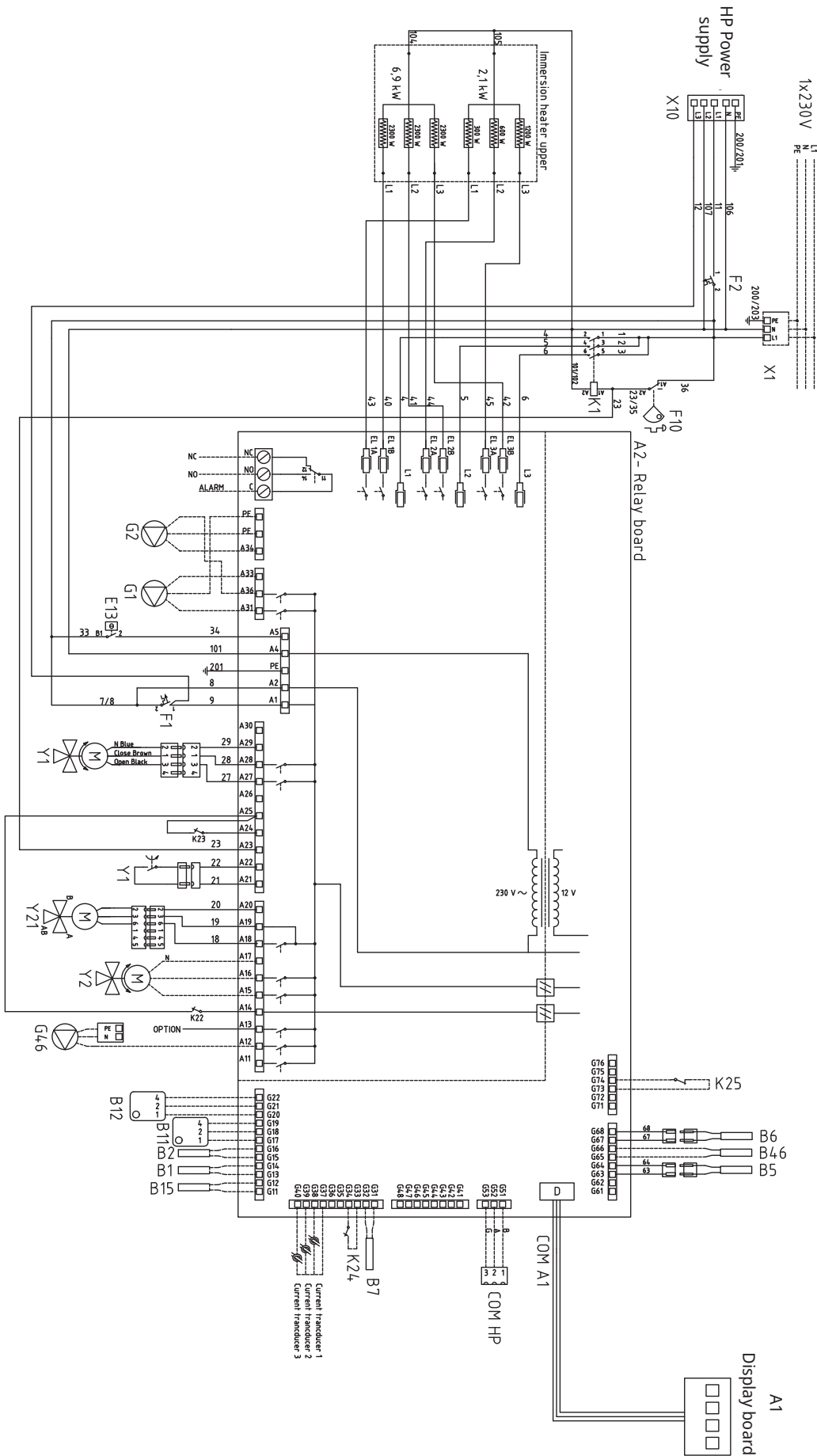

586626

14.10 Wiring diagram tank 230V 3~

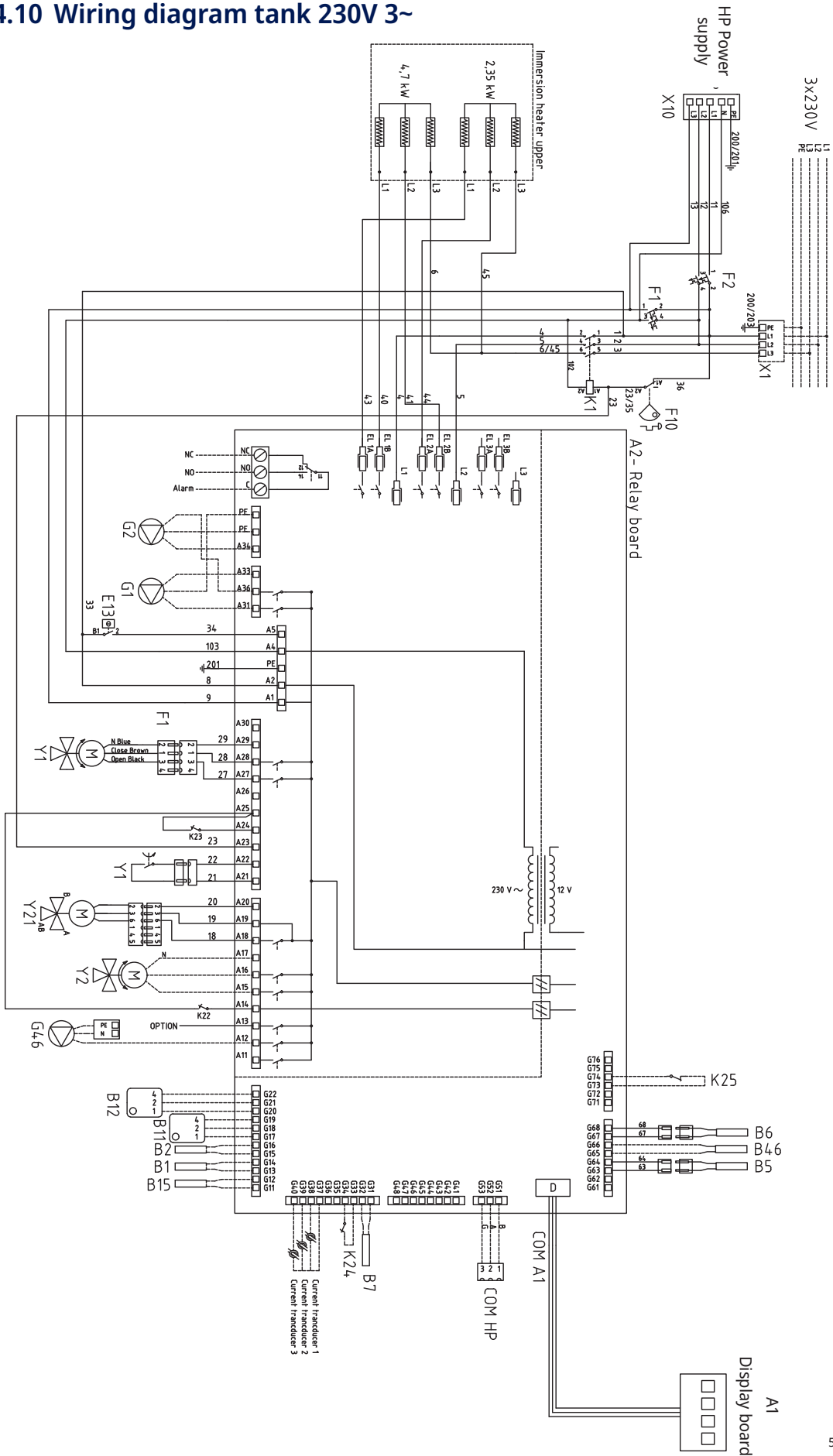

586656

14.11 Wiring diagram heat pump 400V 3N~

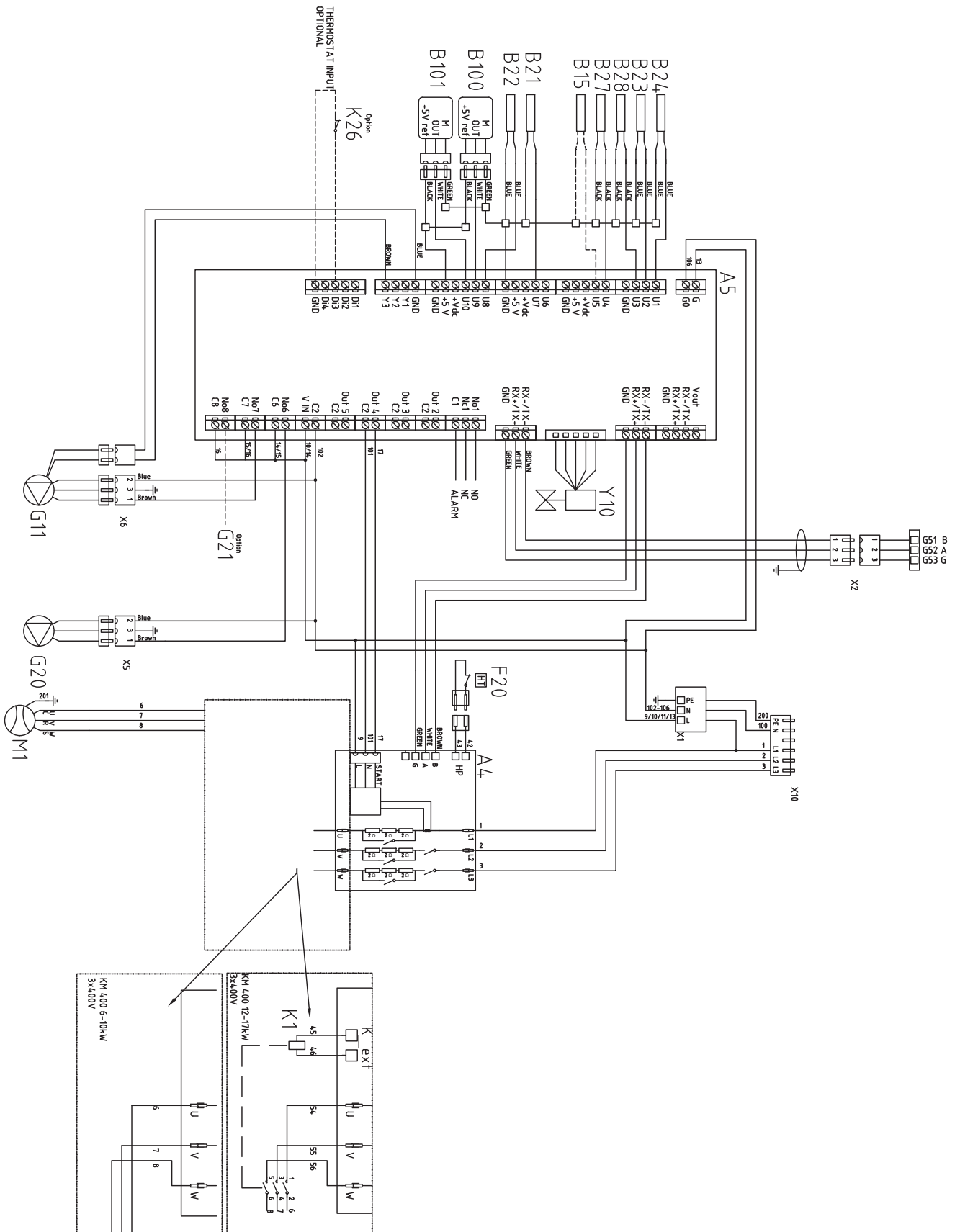

14.12 Wiring diagram heat pump 230V 1N~

WITH NET 3x230V
PHASE L2 = (N)

LOOK AT ELECTRICAL DIAGRAM CONTROL UNIT

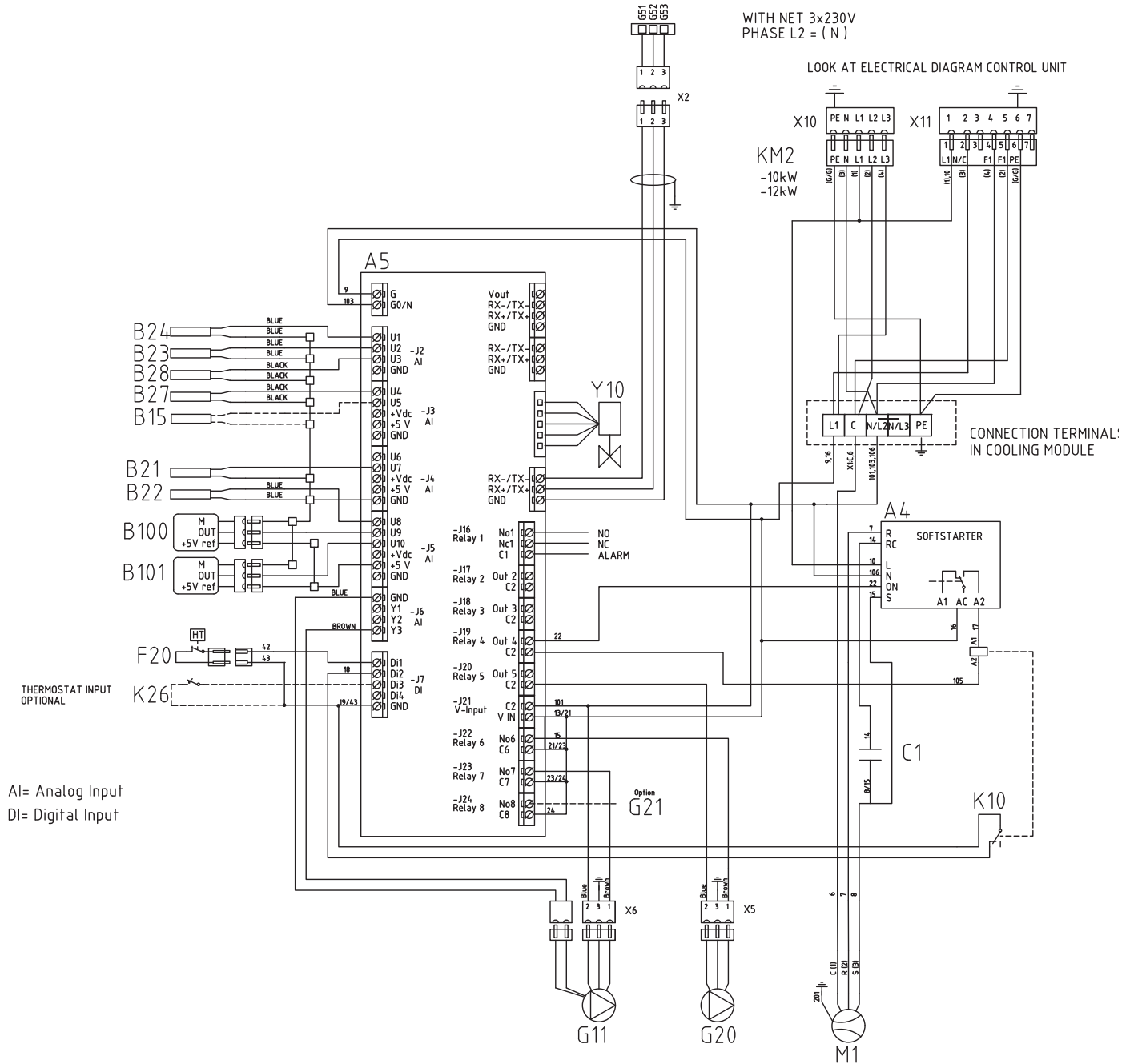

14.13 Component list, wiring diagram

No.	Component	
A1	Display	
A2	Relay/main card	
A3	CTC Solar controls/Expansion card	
A4	Soft-start card with motor protection and contactor function	
A5	HP control card	
B1	Primary flow sensor 1	NTC 22
B2	Primary flow sensor 2	NTC 22
B5	Upper tank sensor	NTC 22
B6	Lower tank sensor	NTC 22
B7	Return sensor	NTC 22
B11	Room sensor 1	NTC 22
B12	Room sensor 2	NTC 22
B15	Outdoor sensor	NTC 150
B21	Discharge gas sensor	Type 3/NTC 050
B22	Suction gas sensor	Type 1/NTC 015
B23	Brine sensor in	Type 1/NTC 22
B24	Brine sensor out	Type 1/NTC 22
B27	HP in	Type 2/NTC 22
B28	HP out	Type 2/NTC 22
B46	Sensor external tank - Differential thermostat function	NTC 22
B100	High pressure sensor	
B101	Low pressure sensor	
C1	Condenser, compressor	
COM HP	Communication Heat Pump G51 = Brown cable, G52 = white cable, G53 = green cable.	
E13	Backup heating thermostat	
F1	Automatic circuit breaker 10 A	
F2	Automatic circuit breaker HP 10 A	
F10	Max thermostat	
F20	High pressure switch	
G1	Heating circ pump 1	
G2	Heating circ pump 2	
G11	Charge pump	
G20	Brine pump	
G21	Groundwater pump, signal 230V, option	
G40	DHW Circulation pump (Not controlled by the product, separate control/constant voltage)	
G46	Charge pump external tank - Differential thermostat function	

No.	Component
H	H-tank. Internal main tank in the product
K1	Contactor 1
K2	Contactor 2
K10	Relay
K22	Flexible remote control/ SmartGrid
K23	Flexible remote control/ SmartGrid
K24	Flexible remote control/ SmartGrid
K25	Flexible remote control/ SmartGrid
K26	Thermostatic control, option
M1	Compressor
X1	Terminal block, incoming supply
X10	Terminal block, HP supply Black connector
Y1	Mixing valve 1
Y2	Mixing valve 2
Y11	Non return valve
Y21	3-way valve DHW
Y22	3-way valve DHW
Y98	Expansion vessel
Y99	Expansion vessel

15. Installation Communication

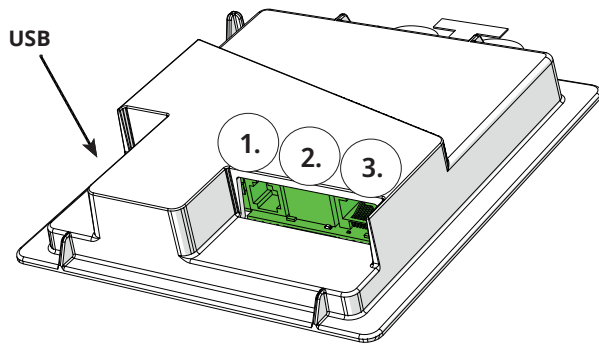

The back of the display unit has 3 communication ports.



Menu: "Installer/Define/Communication".



Display communication ports

1. Port 1. RS485 port without galvanic protection. For external equipment, e.g. BMS, CTC AXS

Define AXS:

"Yes" permits BMS via the RS485 port and "CTC AXS" accessories for wireless sensors/WiFi communication, refer to the accessory manual for installation.

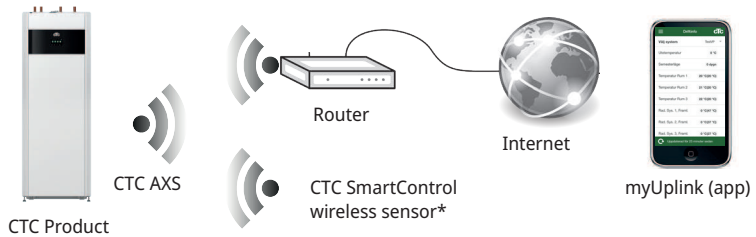

2. Port 2. Network jack (ethernet), see connection information on following page.

Define the app:

myUplink: "Yes" enables connection to the app.

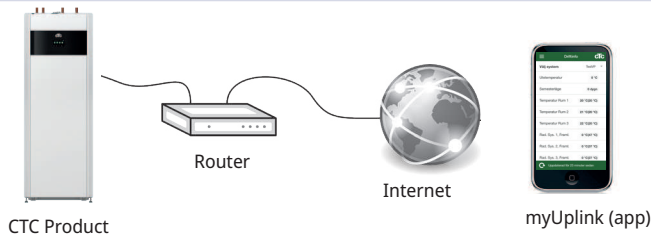

Define Web:

"Yes" permits network connection, the "CTC Remote" screen mirror feature and BMS function with remote control via network cable to local network.

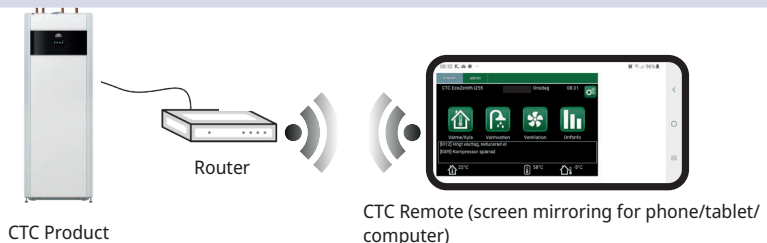

3. Port 3. Communication between the product's electrical cabling and display: Factory fitted.

*CTC SmartControl is also available with a gateway connected to Port 3. Refer to the CTC SmartControl accessories manual.

15.1 Installing the network cable

! Turn off the product's main switch before opening the front.

1. Remove the front plate. Run the network cable in front of the product's top cover edge according to the arrows.

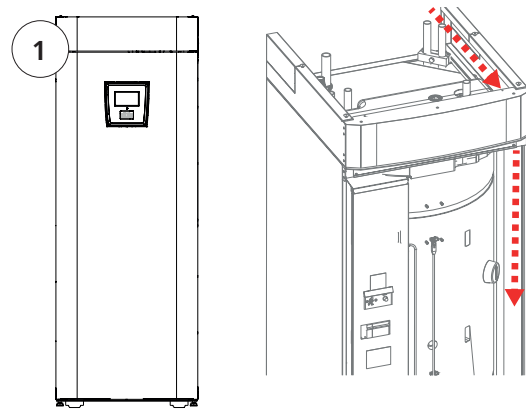

2. Open the ferrite from the packaging, clamp around the ethernet cable with the connector.

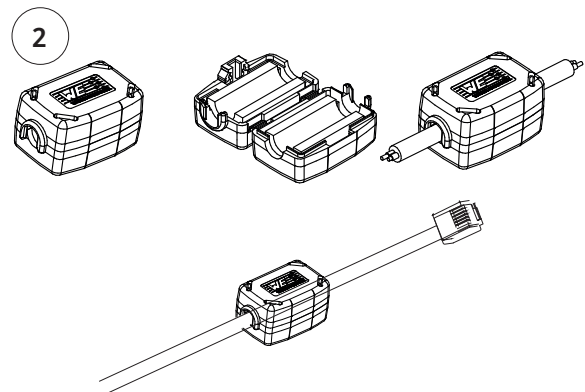

3. Connect the ethernet cable in the middle (Port 2).

4. Carefully refit the front. Pay attention to the cables.

5. Connect ethernet cable to network port or router.

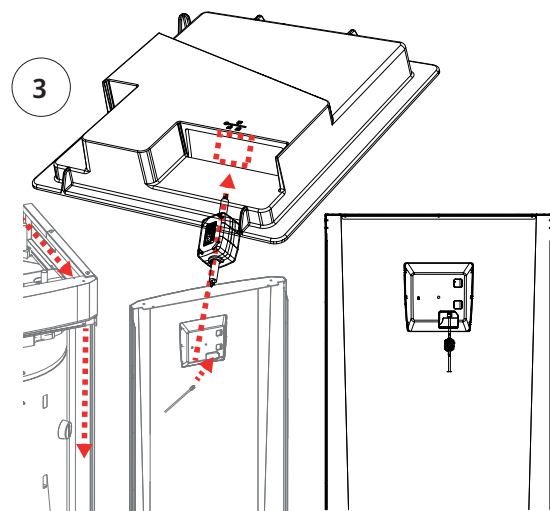

To activate and define a connection, refer to the "Installer/Define/Communication" menu. A more detailed description can be found in the "Control System" chapter.



15.2 Remote - Screen Mirroring

- Connect the ethernet cable, see previous page.
- Installer/Define/Communication/Web - Yes. Permits the product to connect with unencrypted web traffic on local area networks. Internet router and firewall required.
- Installer/i - Scan the QR code with a tablet or smartphone. 
- Save as favourite/icon on phone/tablet/computer. When your phone/tablet is connected to your local network, the product can be used with your device's touchscreen in the same way as the product's screen.
- In the app: scan QR code or enter address "http://ctcXXXX/main.htm". (XXXX = the last four digits of the display serial number, for example S/N 888800000040 = "http://ctc0040/main.htm"). In case of problems: click the link to update to the device's current IP no.

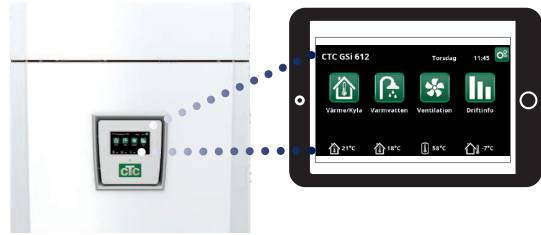

Tablet/Smartphone/PC as a touchscreen for local area network "Installer/Define/Communication/Web" - "Yes".

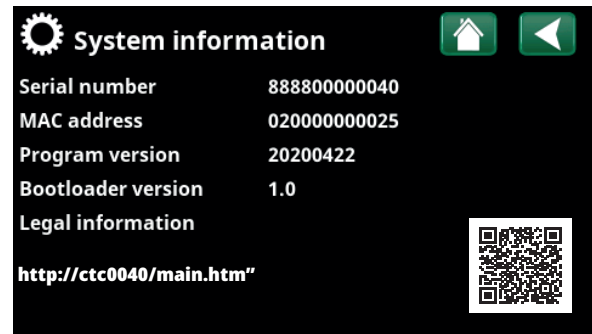

15.3 myUplink - App

Define myUplink. See "Installer/Define/Communication/myUplink - Yes".

Installing the app.

- Download myUplink from the App Store or Google Play.
- Create an account.
- Follow the instructions in the app's Help feature.

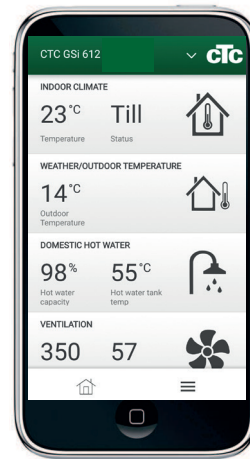

16. First start

When the heat pump is delivered, the compressor is blocked to avoid accidental start-up. The heat pump can be installed and started before the bedrock/ground source or air-to-water heat pump is commissioned.

The heat pump can also be started without the room sensor installed, as the set curve will control the heating. Deselect the room sensor under the "Settings" menu. However, the sensor can always be fitted for the alarm LED function.

Before first start

1. Check that the heat pump and system are water-filled and bled. (The heat pump can be bled through the bleed valve on the top cover of the product).
2. Ensure that, where applicable, the brine system is filled with water and antifreeze and that it is bled or ensure that the compressor is blocked. (This applies to docking with a brine-to-water heat pump)
3. Check that all connections are tight.
4. Check that sensors and the radiator pump are connected to the power source.
5. The backup heating thermostat has OFF as its factory setting. Recommended mode is ❄️ = Frost protection setting, approx. +7 °C. The backup heating thermostat is located in the electrical switchboard behind the front panel. It is in the OFF position when it is turned anticlockwise as far as it will go (the screwdriver slot should be vertical).

Screwdriver slot



Symbol for backup heating thermostat:

NB: At the end of the installation, check the current transformers' connection. In this situation it is important that you have switched off any major consumers of electricity in the house. Also make sure that the backup thermostat is turned off.

First start

Switch on the power using the safety switch, the display will turn on.

The product will now ask the following:

1. Select the language and push OK.
2. Confirm that the system is filled with water and press OK. Press "Next"
3. Size of main fuse Choose between 10 and 35 A.
4. Set the supply voltage 400 V 3N~ (230 V 1N~/230 V 3~ only applies to export variants).
5. Specify the maximum electric heater power. Choose between 0.0 and 9.0 kW in different steps.
The output power applies to the electric heater in the upper tank. This setting can be changed after installation in the "Installer/Settings/Electric Heater" menu.
6. Select the option permitting the compressor (if the collector system is ready or the air/water pump is already installed). When the compressor is started for the first time, a check is automatically carried out to ensure that it is running in the correct direction. An error message is displayed in the panel display if it is rotating in the wrong direction. Switch any two phases to change the direction of rotation.
7. Brine pump On, Auto (Auto/10d/On) (Only for brine-to-water heat pumps) Auto means that the brine pump is automatically in operation at the same time as the heat pump (factory setting).
10d means that the brine pump is running continuously during the first 10 days in order to assist with bleeding.
"On" means that the brine pump is running constantly.
8. Specify Type for Heating circuit 1 Choose between "Radiator" or "Underfloor" by pressing "+" and "-". Check the grey text below to see how the temperature is affected for "Maximum Primary Flow", "Inclination" and "Adjustment". Press "Next".

The product will start and the start menu will be displayed. Enter the set values in the parameter list so that the customer knows what has been set in addition to factory settings during installation.

 Save these settings under: "Installer/Settings/Save settings".

www.ctc.se, www.ctc-heating.com
+46 372 88 000
Fax: +46 372 86 155
P.O Box 309 SE-341 26 Ljungby Sweden



MADE IN SWEDEN